

*VALGA 6x5*  
*Art.No. 7014741*

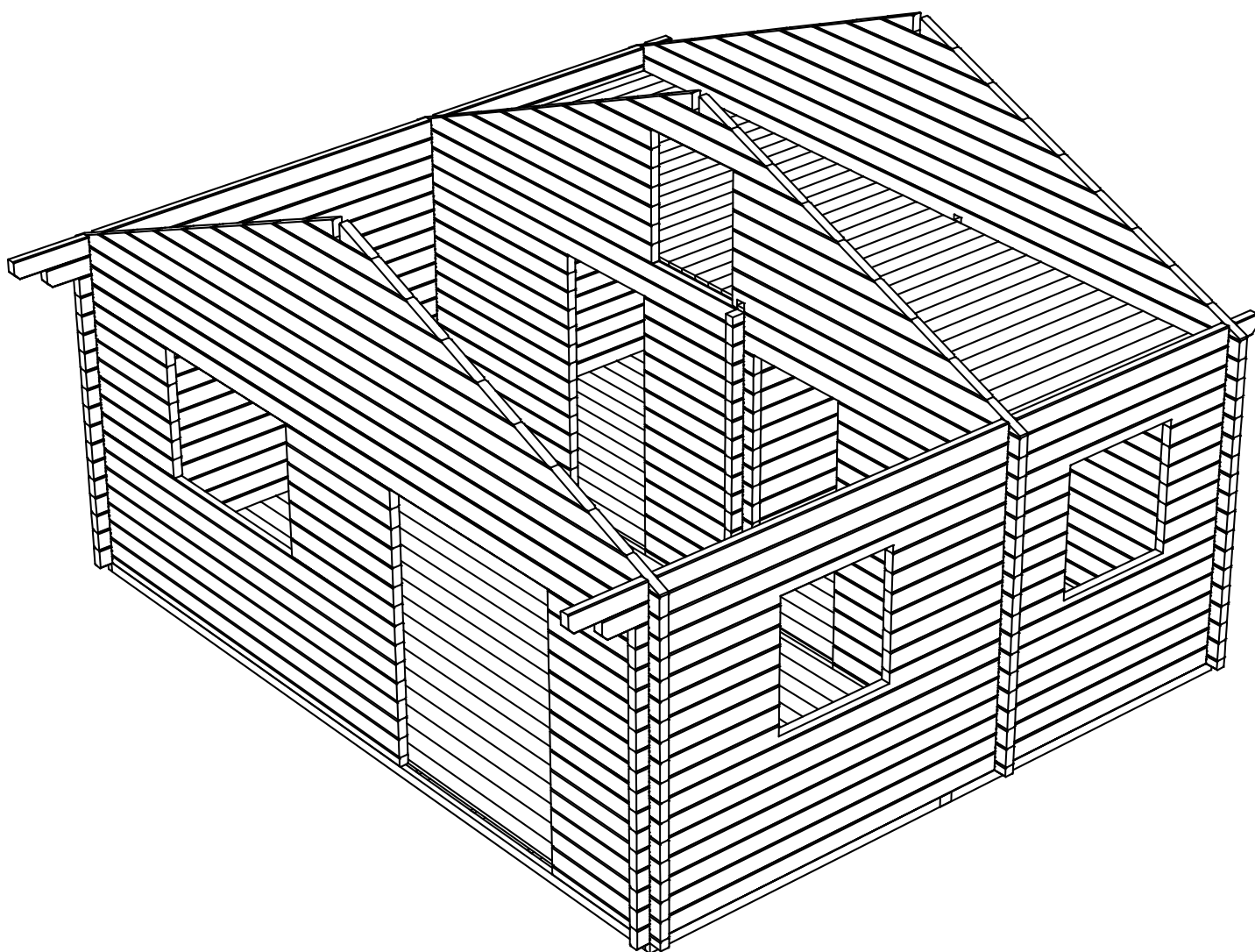

Valga 6x5, Art.No.7014741  
Groundplan - Grundplan - Plan de masse - Planimetria - Plattegrond - Põhiplaan

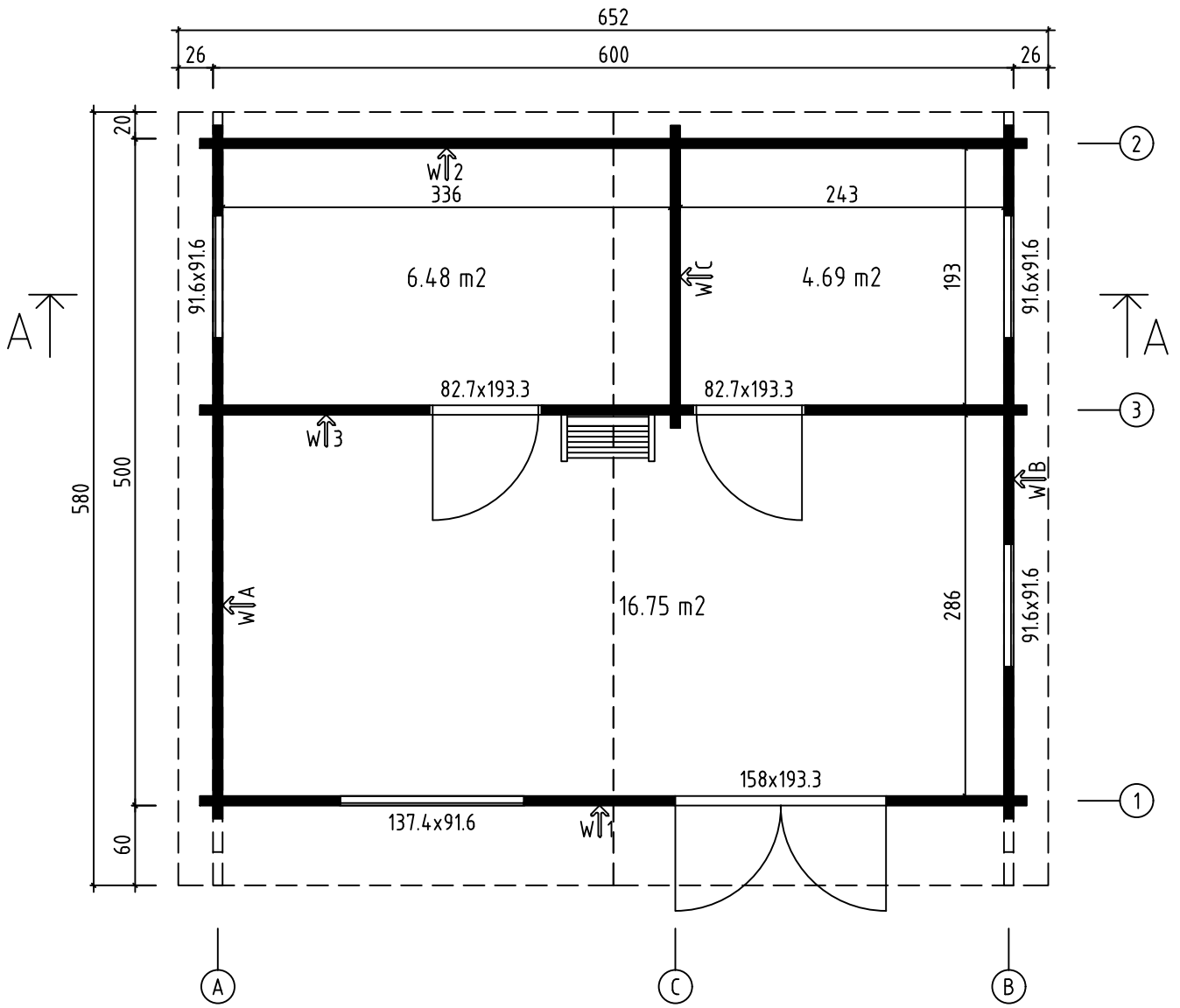

Valga 6x5, Art.No.7014741  
Groundplan - Grundplan - Plan de masse - Planimetria - Plattegrond - Põhiplaan

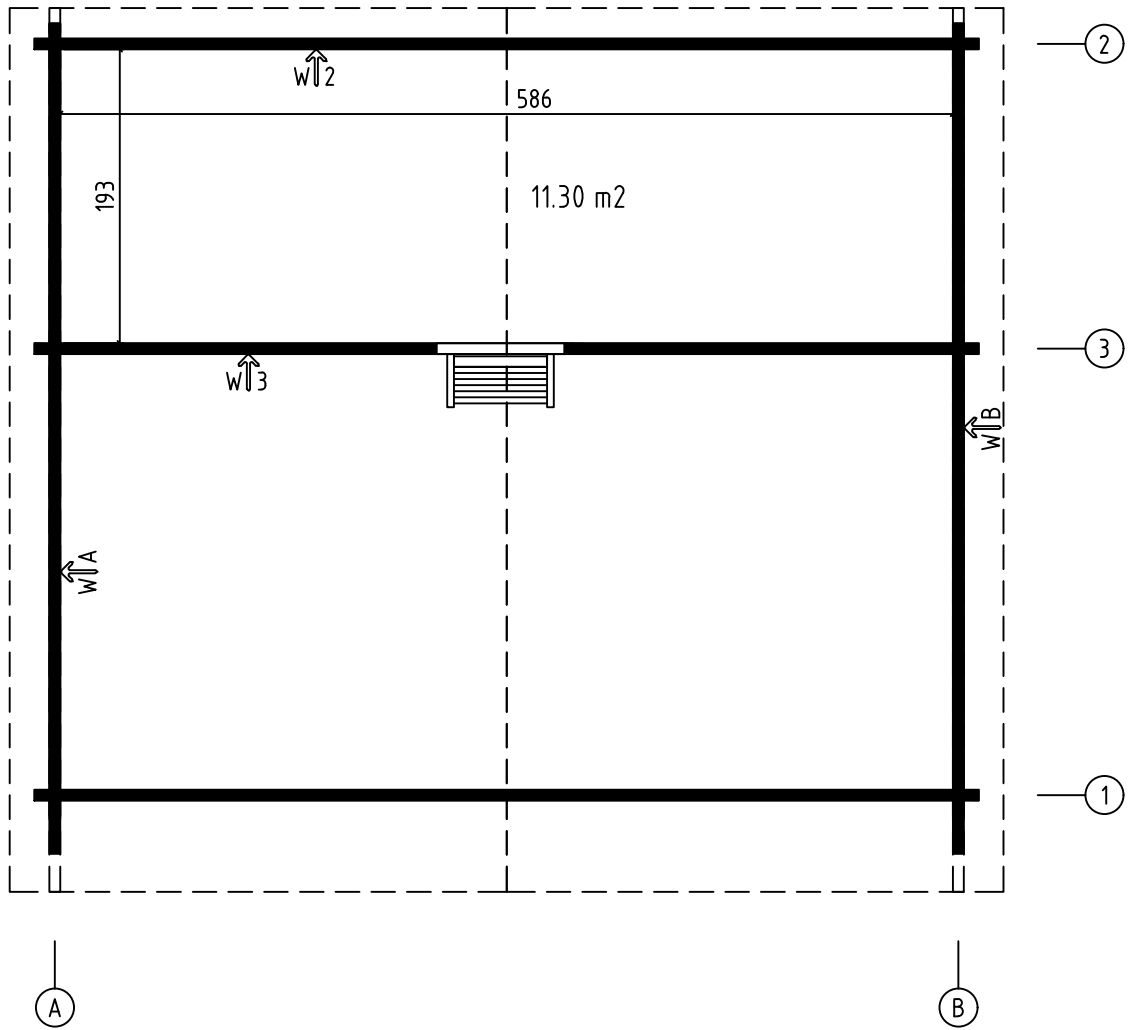

Valga 6x5, Art.No.7014741  
 Foundation - Fundament - Fondation - Fundamenta - Fundering - Immutatud  
 alusraam

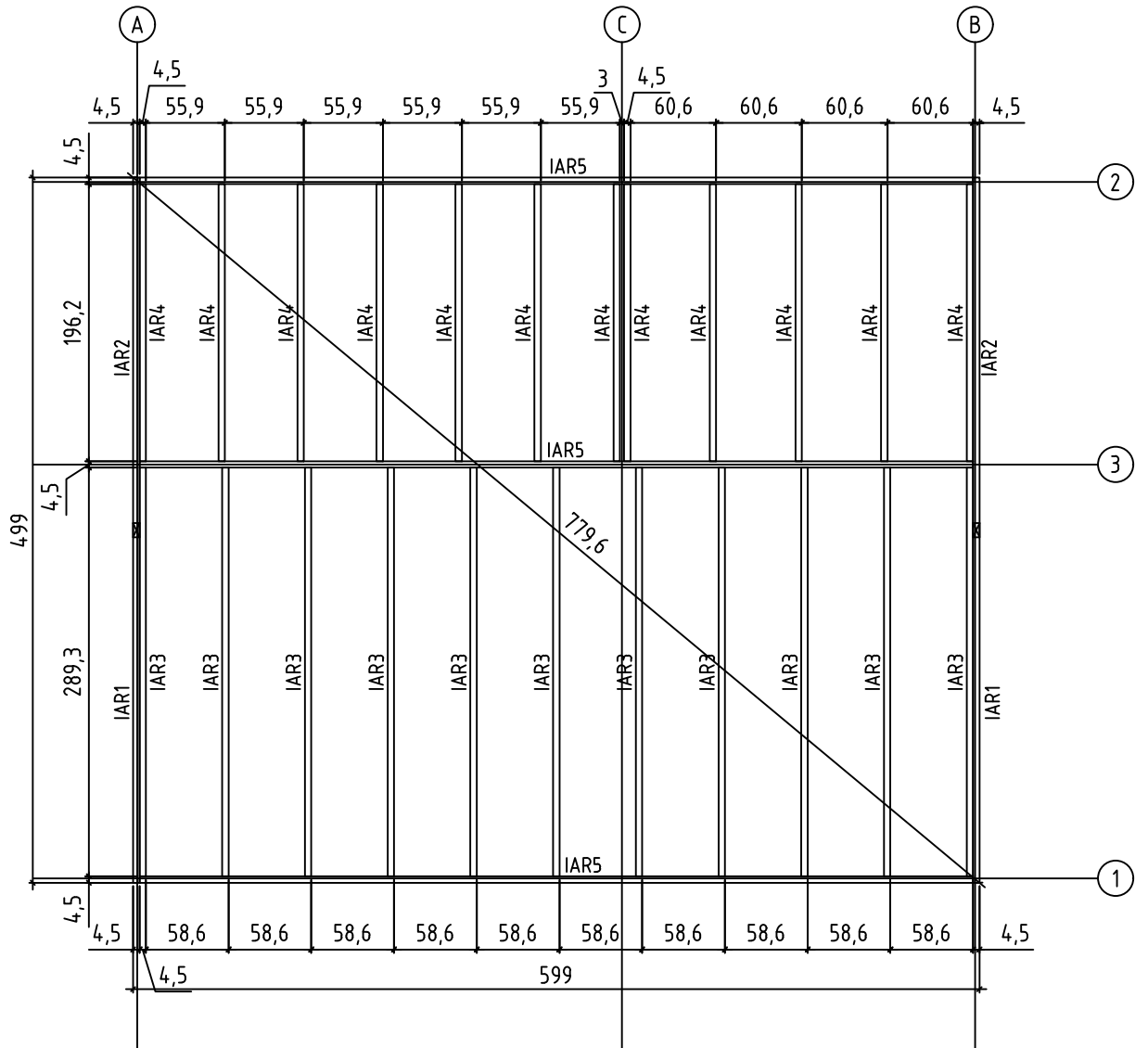

Valga 6x5, Art.No.7014741

Mezzanine floor joists - Halbgeschoss balken - Solives de plancher mezzanine -  
Travi del pavimento mezzanino - Plaatduim scharnier - Vahelaetalad

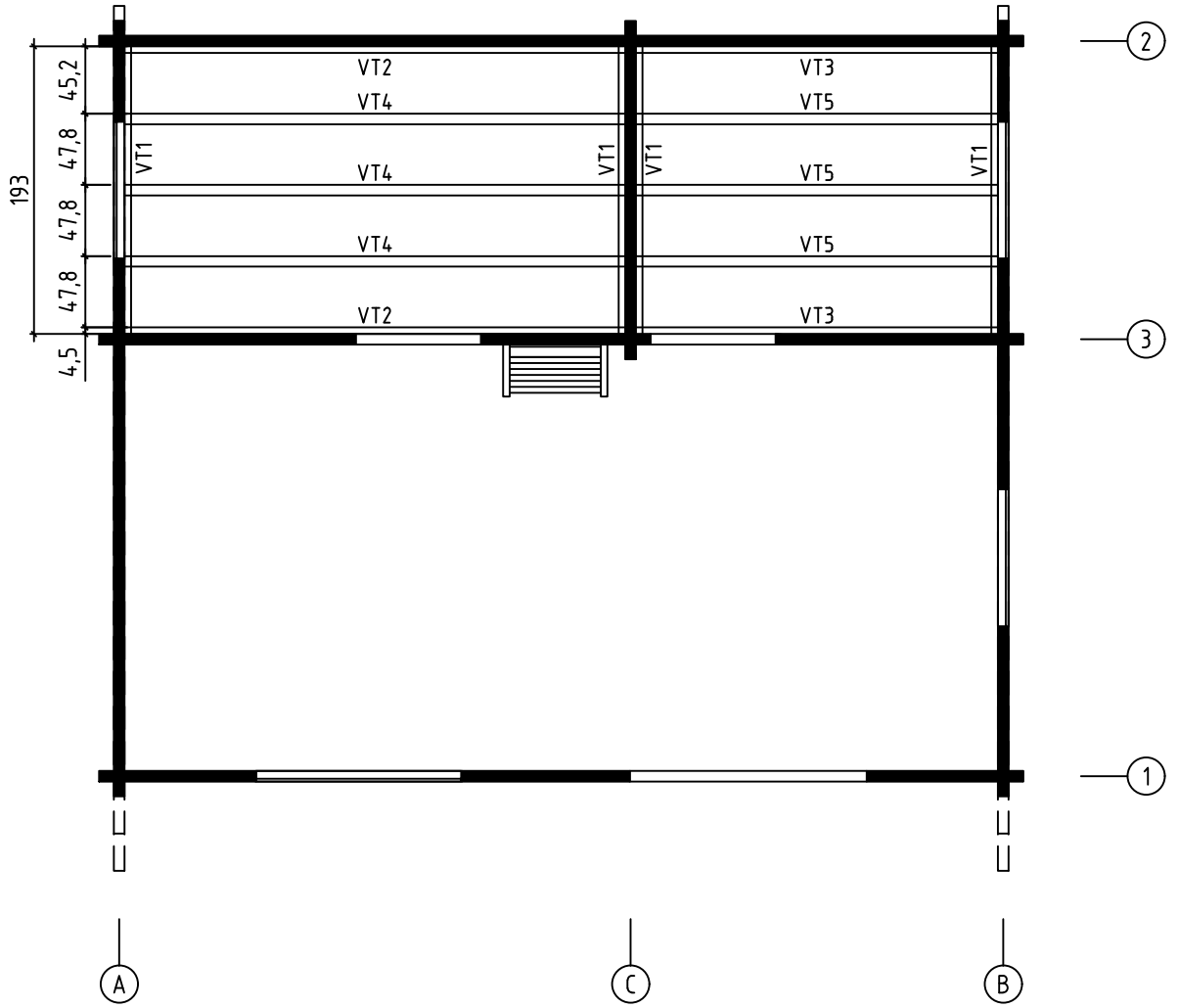

Valga 6x5, Art.No.7014741  
Floor boards - Fussbodenbretter - Plan pose plancher - Pavimento - Vloerhout  
- Põrandalaudis

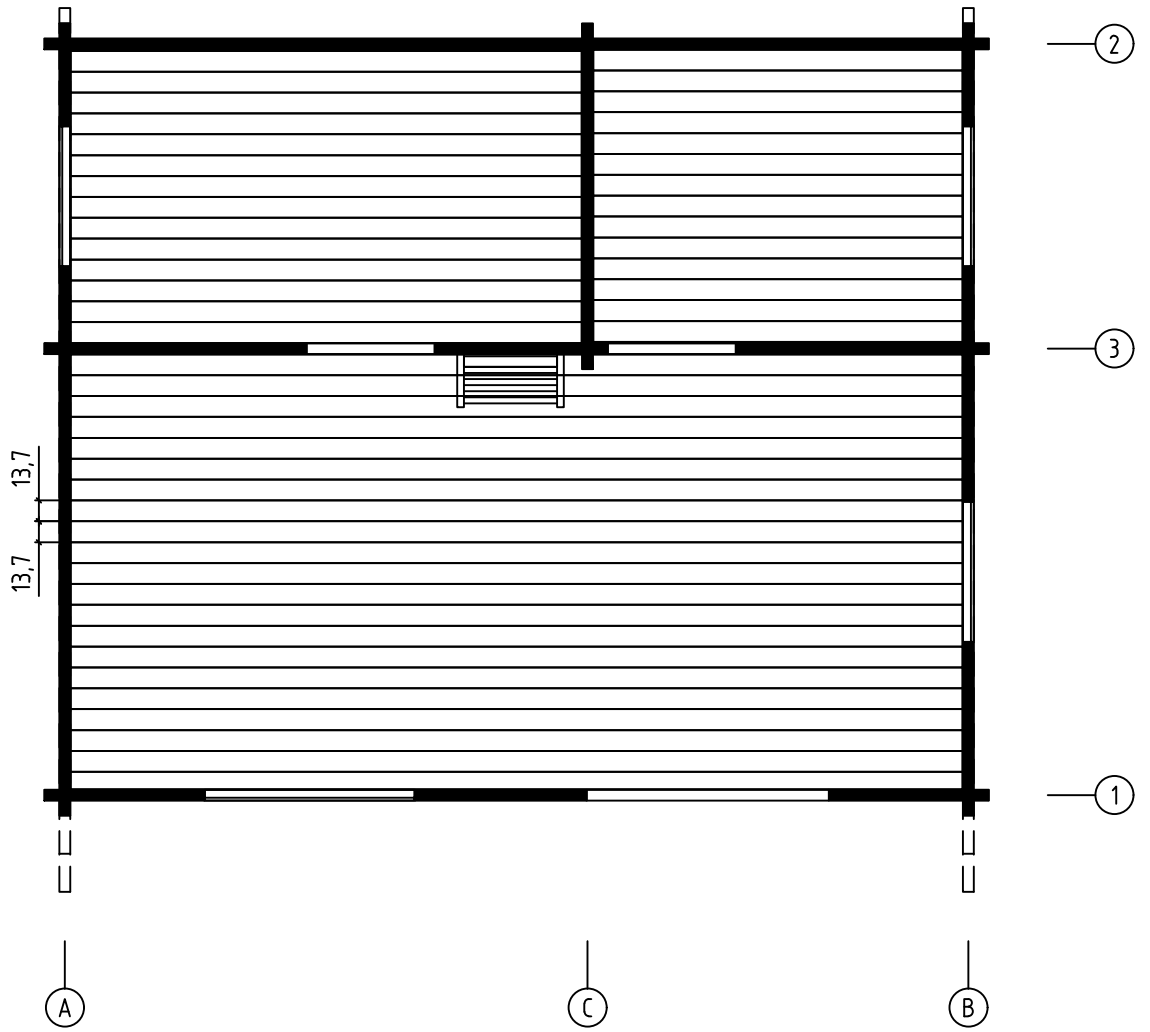

Valga 6x5, Art.No.7014741  
Floor boards - Fussbodenbretter - Plan pose plancher - Pavimento - Vloerhout  
- Põrandalaudis

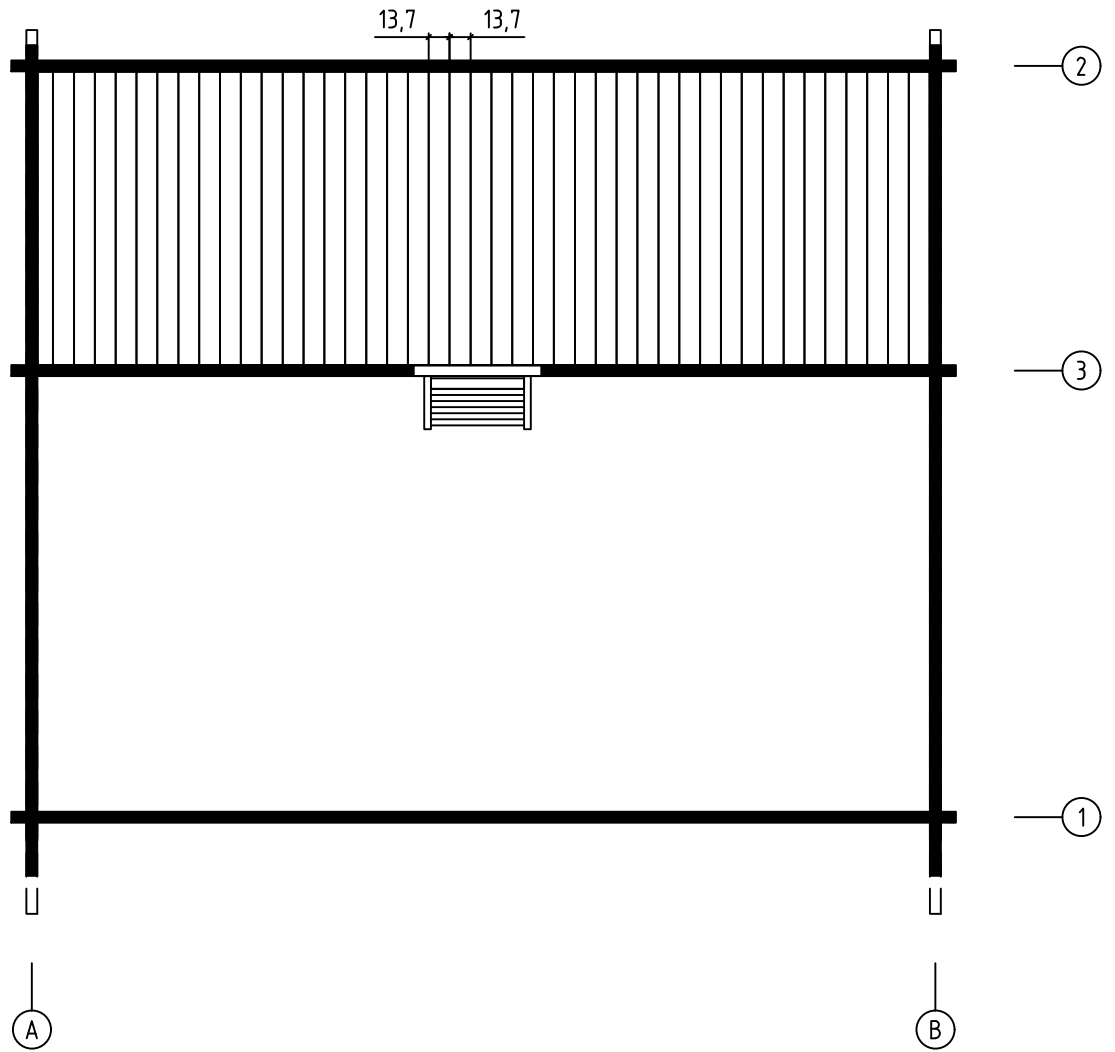

Valga 6x5, Art.No.7014741

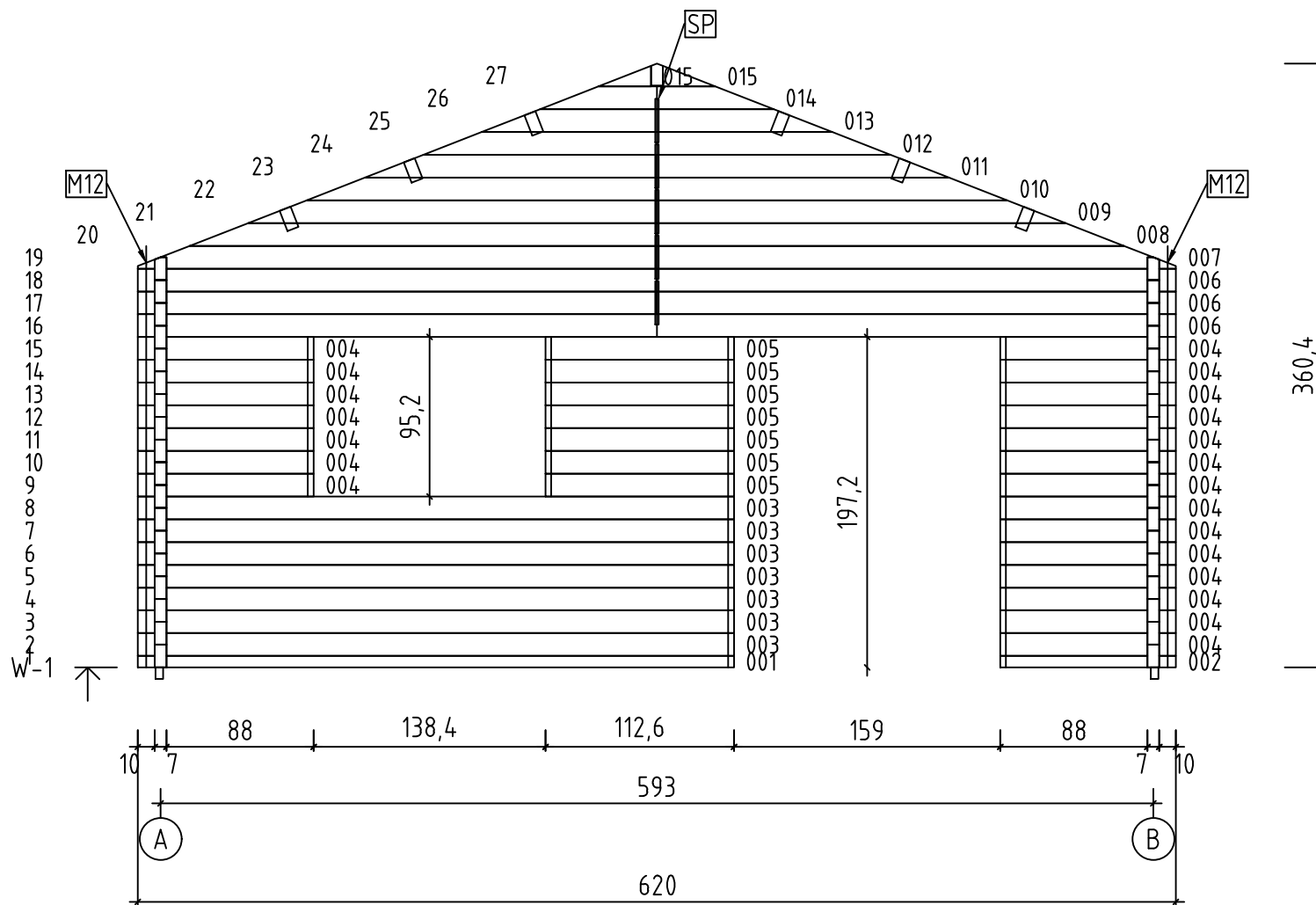



Valga 6x5, Art.No.7014741

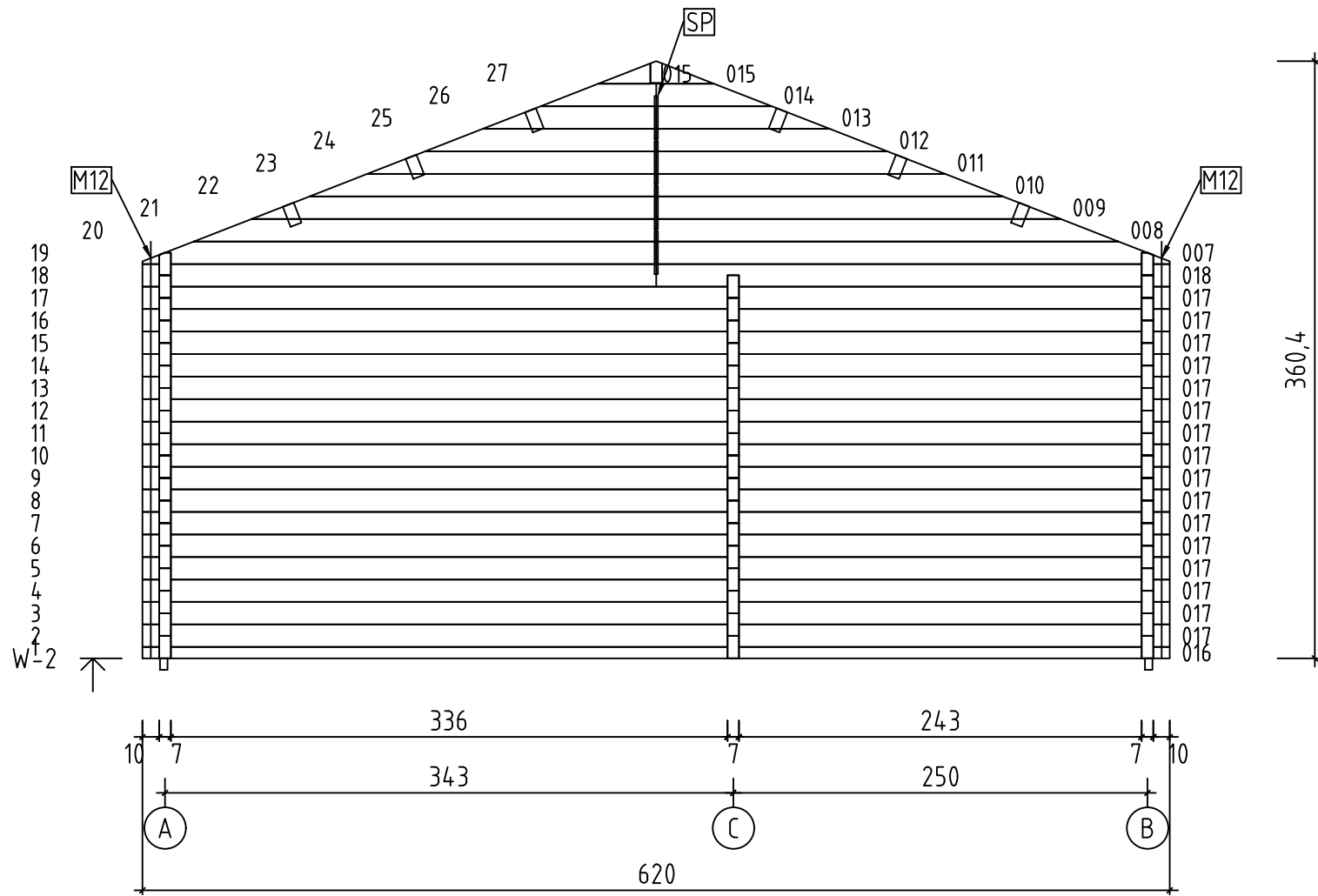

Valga 6x5, Art.No.7014741

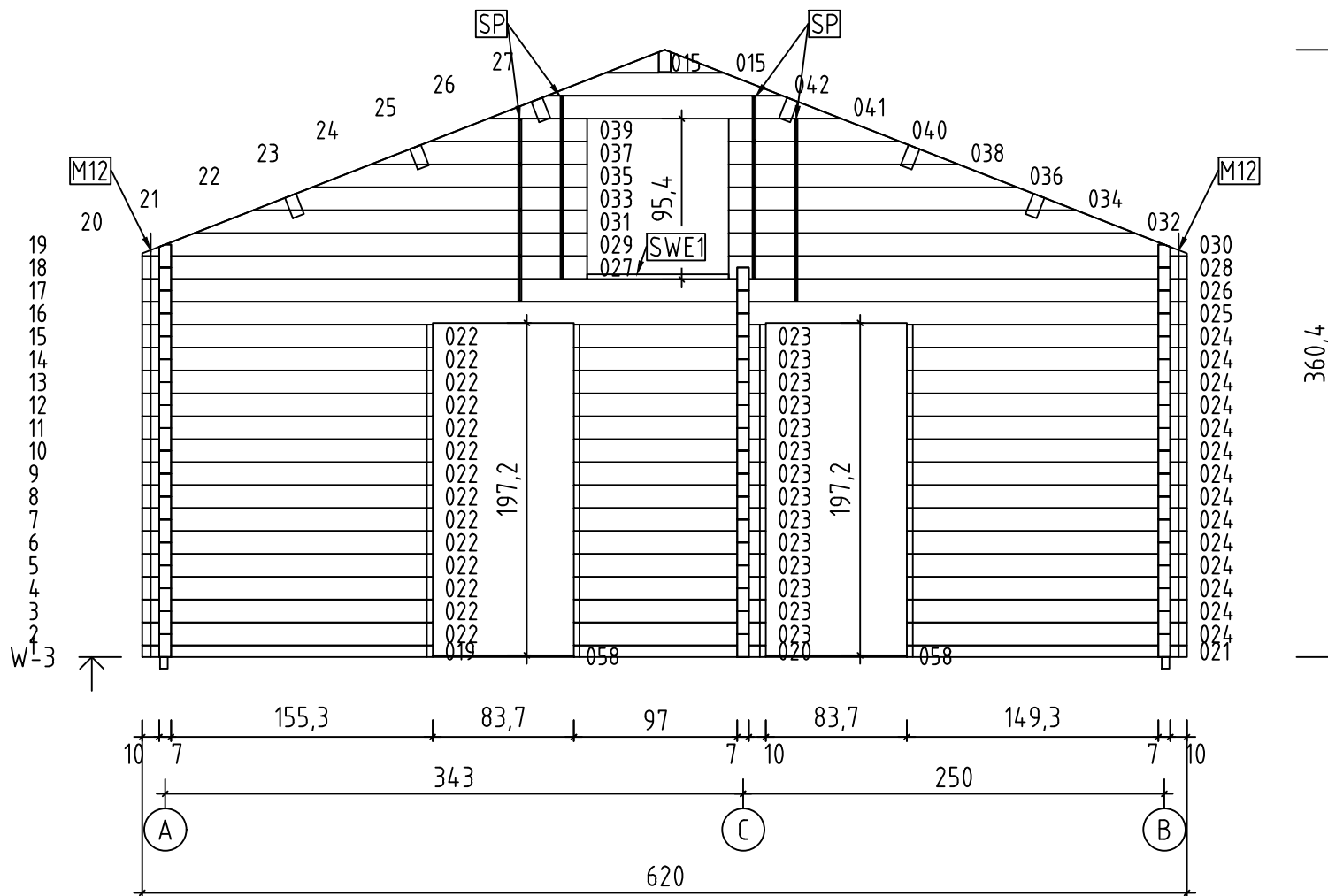

Valga 6x5, Art.No.7014741

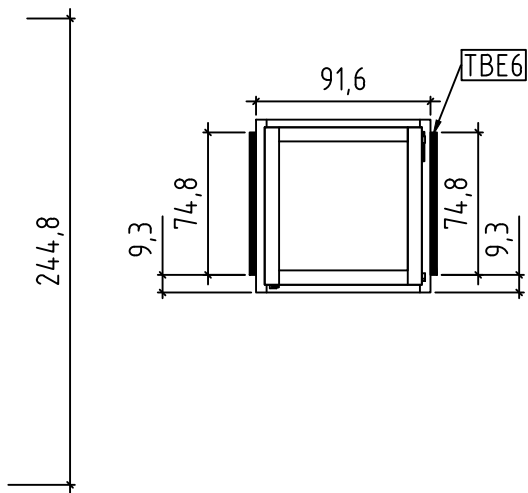
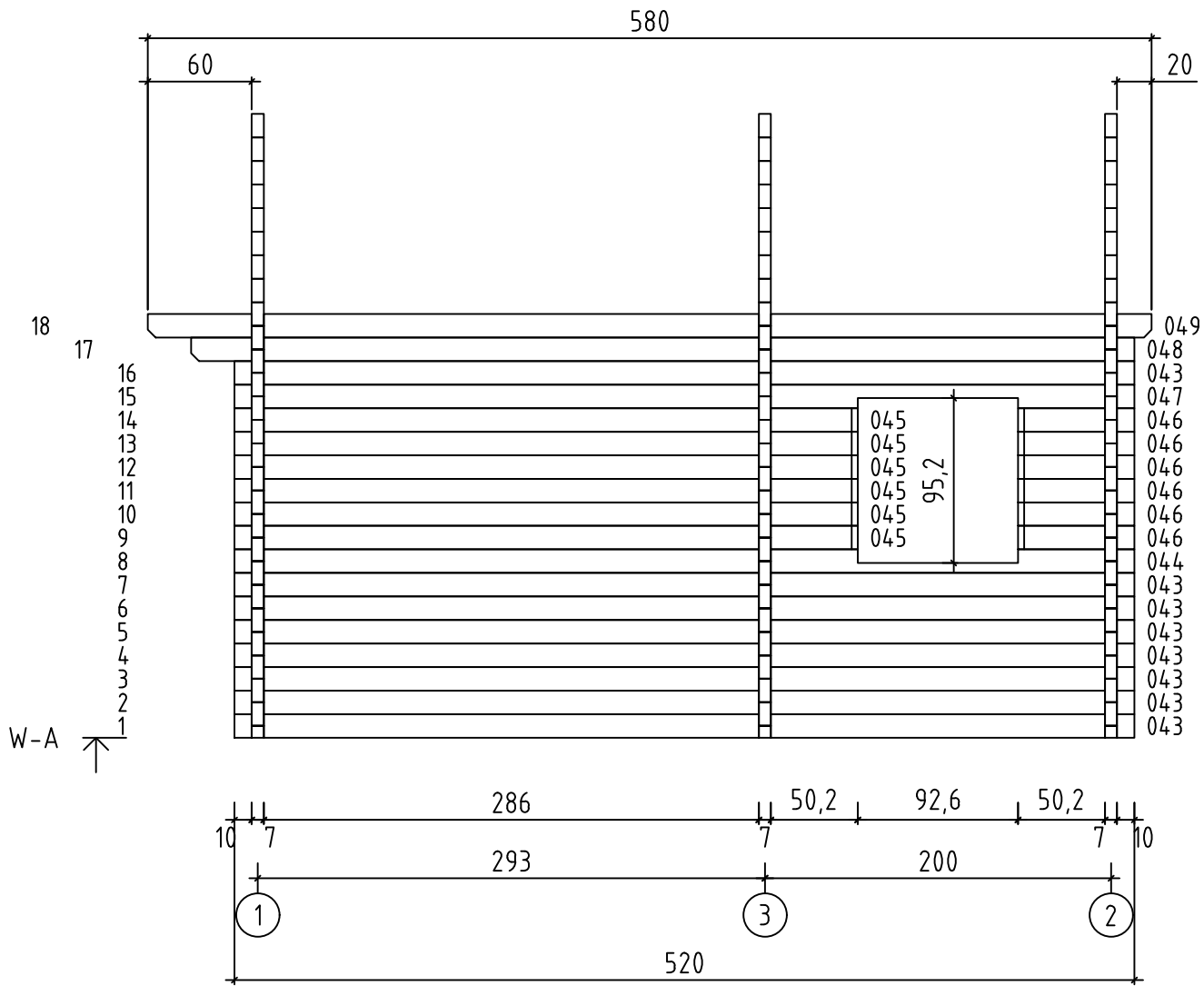

Valga 6x5, Art.No.7014741

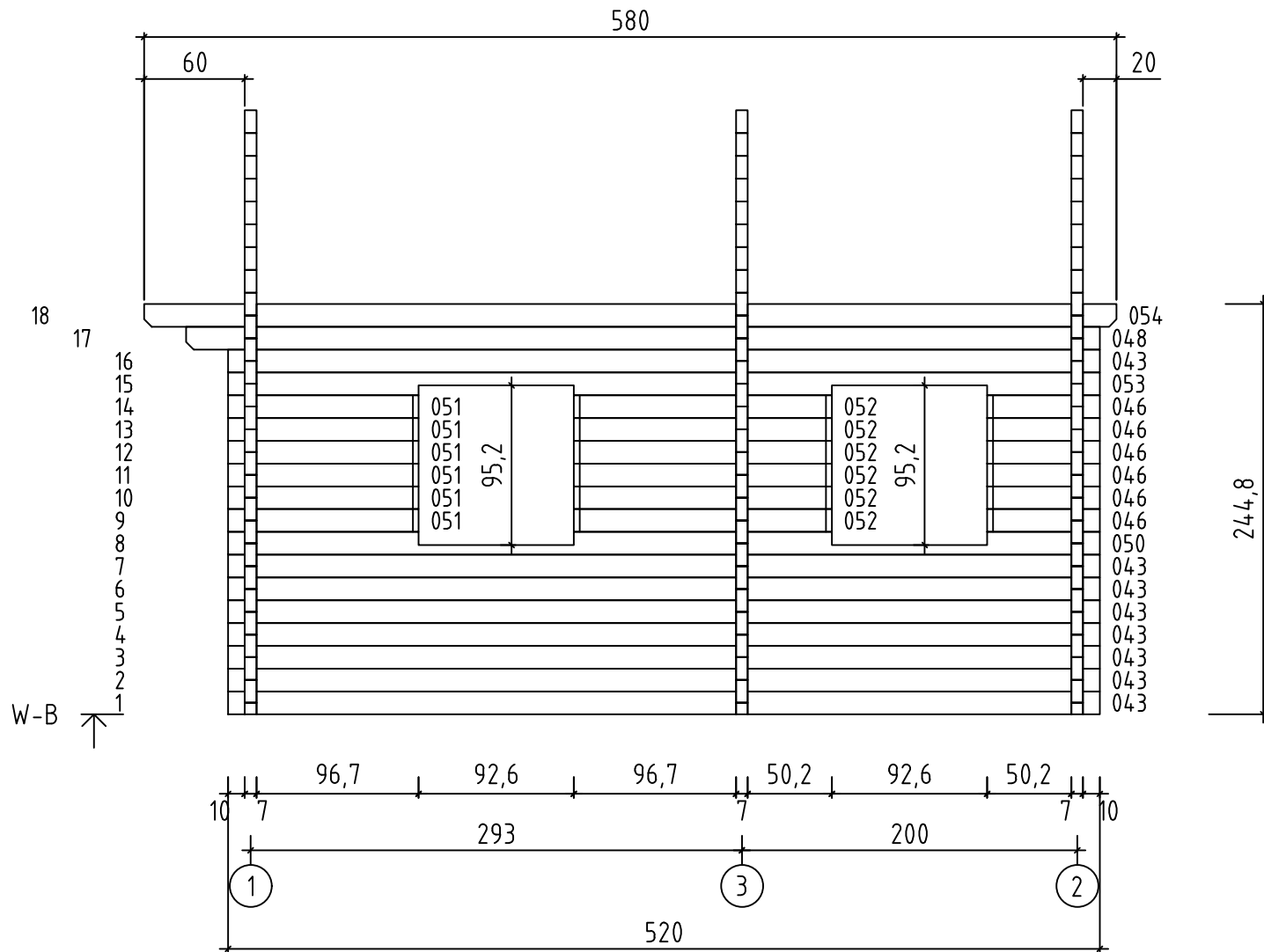



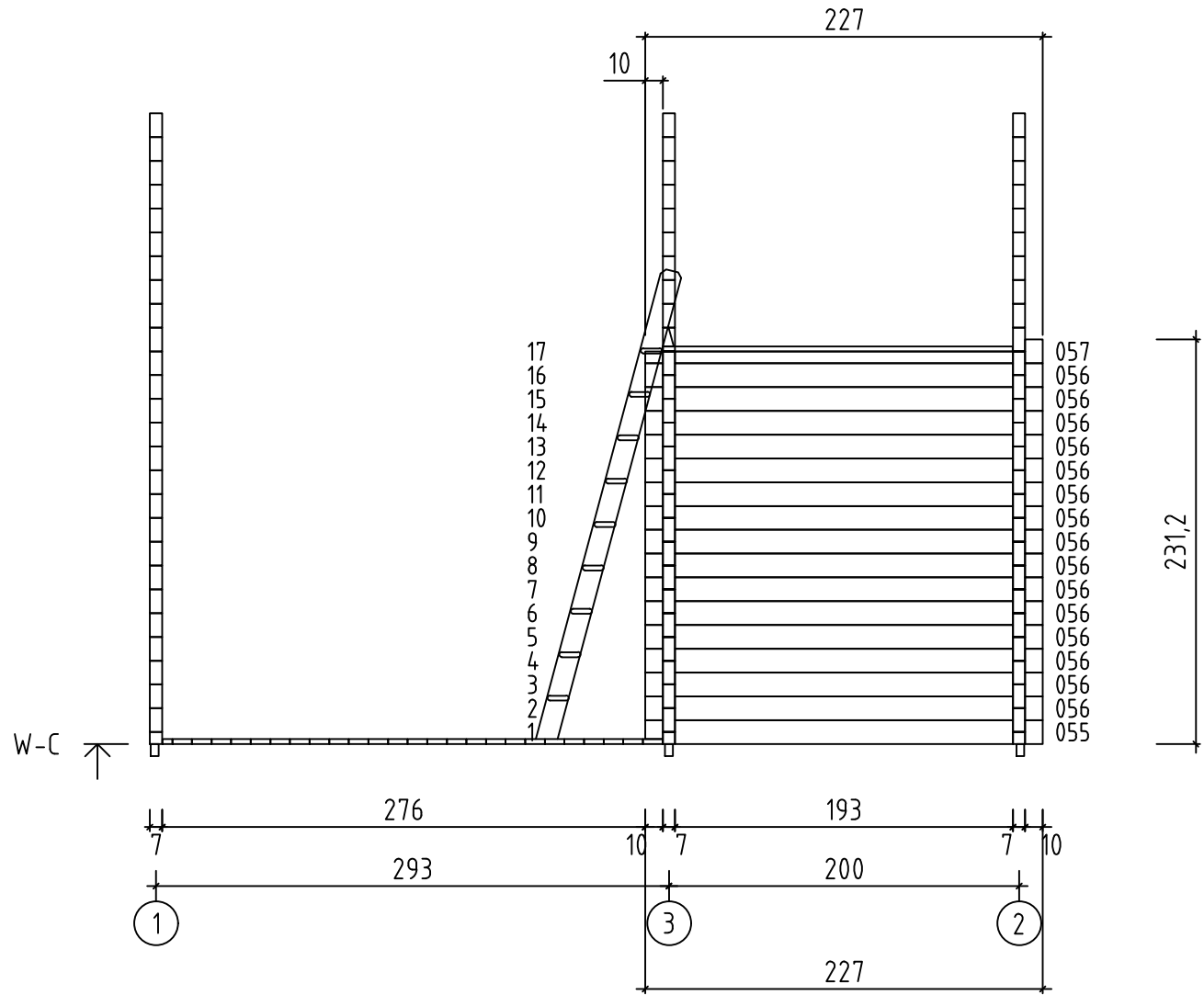

Valga 6x5, Art.No.7014741

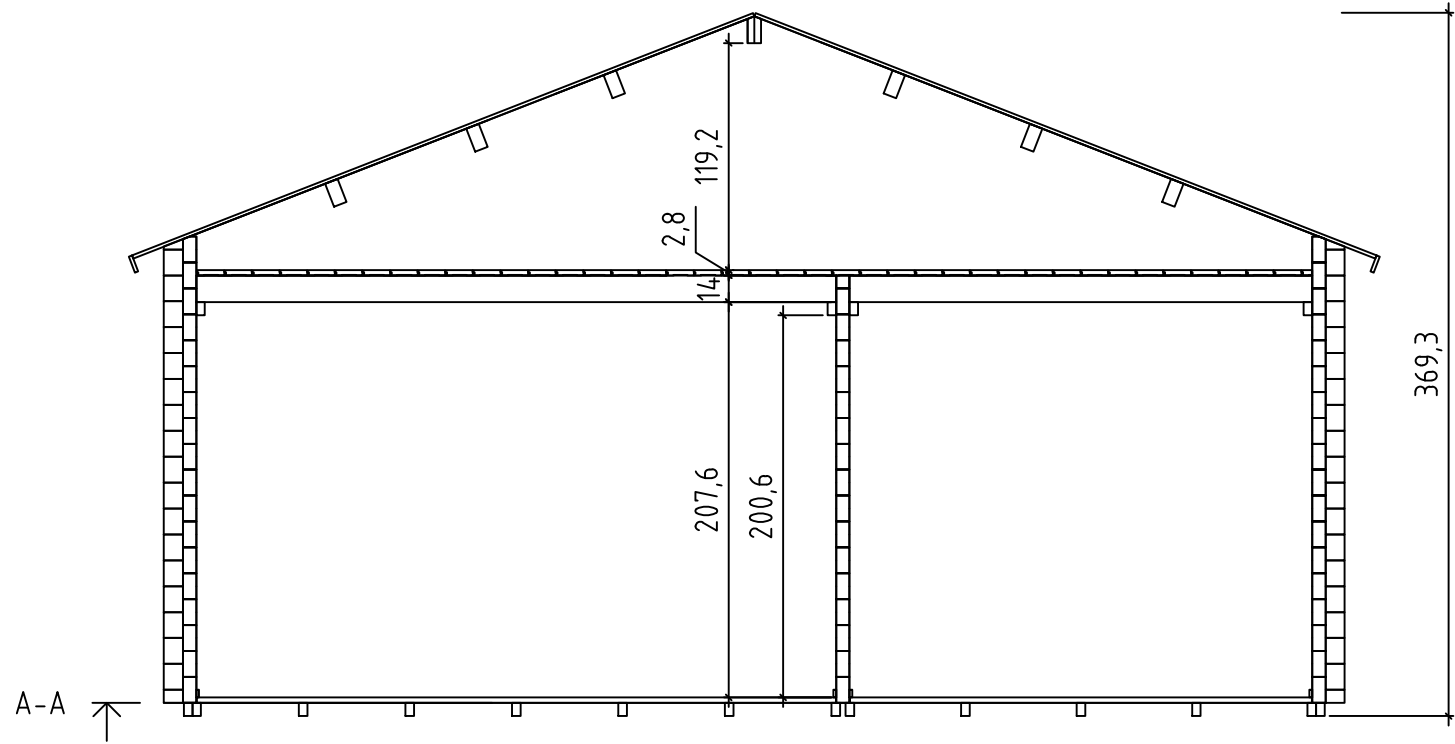

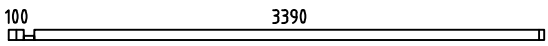
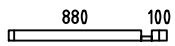
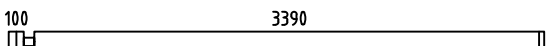
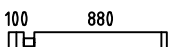
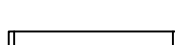
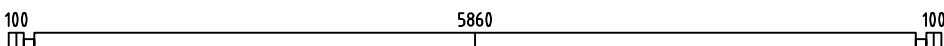
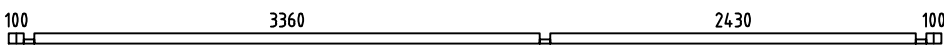
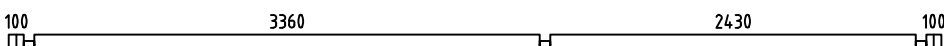
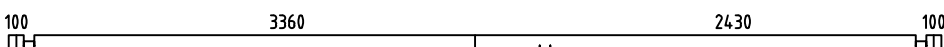
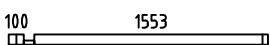
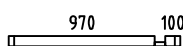
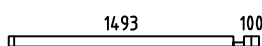
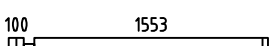
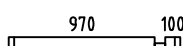
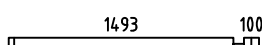
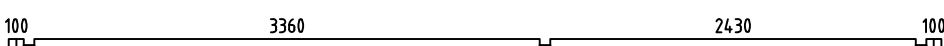
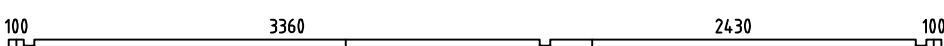
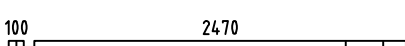
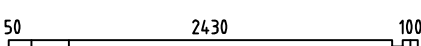
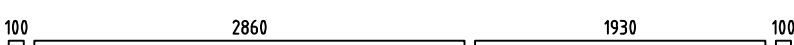
Valga 6x5, Art.No.7014741

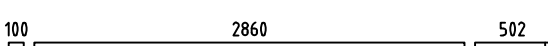
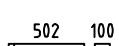

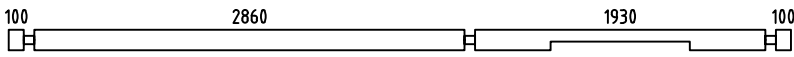
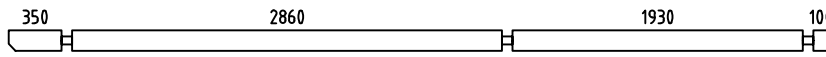
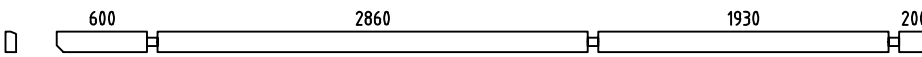
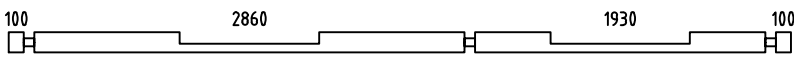
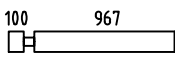
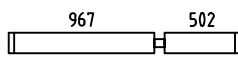
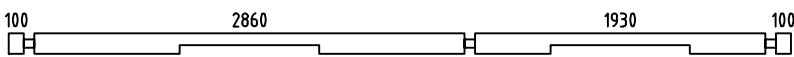
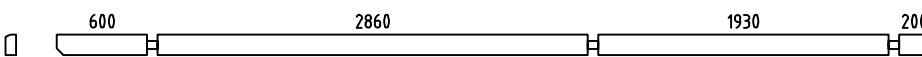
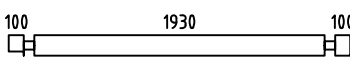
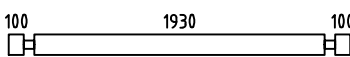
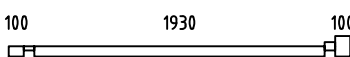

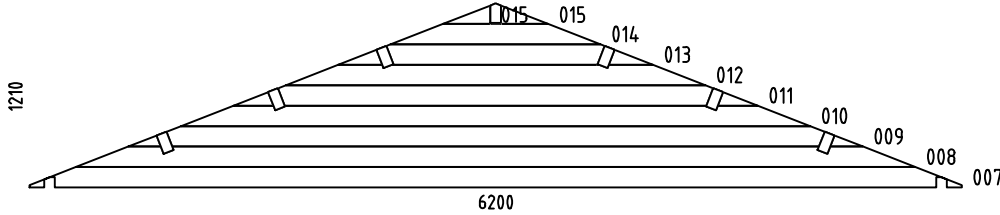
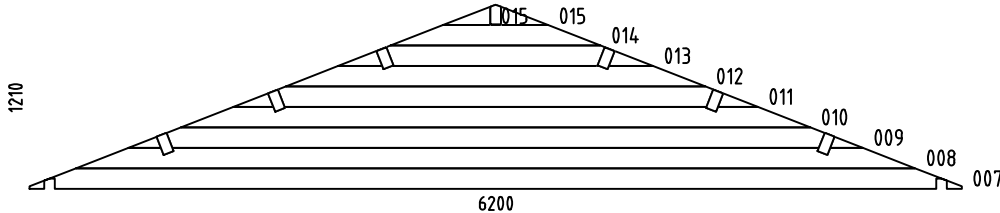
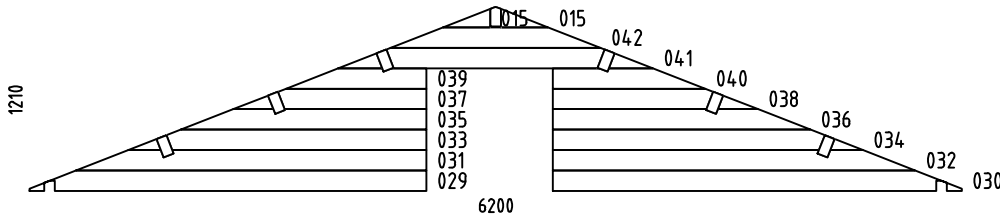
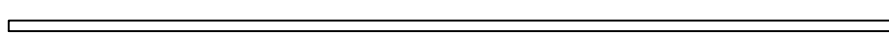
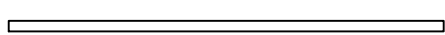







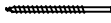
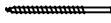
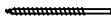
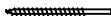
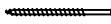
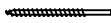
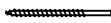
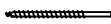

Pos	Valga 6x5, Art.No.7014741 Piece list - Stückliste - Liste des pièces - Elementi - Stuklijst - Tükítabel	Q	P (mm)	L (mm)
001		1	70x68	3560
002		1	70x68	1050
003		7	70x136	3560
004		21	70x136	1050
005		7	70x136	1126
006		3	70x136	6200
016		1	70x68	6200
017		16	70x136	6200
018		1	70x136	6200
019		1	70x68	1723
020		1	70x68	1140
021		1	70x68	1663
022		14	70x136	1723
023		14	70x136	1140
024		14	70x136	1663
025		1	70x136	6200
026		1	70x136	6200
027		1	70x136	2640
028		1	70x136	2720
043		16	70x136	5200
044		1	70x136	5200
045		6	70x136	3602
046		12	70x136	672

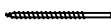
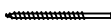
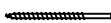
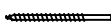
Pos	Valga 6x5, Art.No.7014741 Piece list - Stückliste - Liste des pièces - Elementi - Stuklijst - Tükitalabel	Q	P (mm)	L (mm)
047		1	70x136	5200
048		2	70x136	5450
049		1	70x136	5800
050		1	70x136	5200
051		6	70x136	1137
052		6	70x136	1539
053		1	70x136	5200
054		1	70x136	5800
055		1	70x136	2270
056		15	70x136	2270
057		1	70x136	2270
058		2	70x10	837
W1-1		1		
W2-1		1		
W3-1		1		
IAR5	Foundation - Fundament - Fondation - Fondamenta - Fundering - Immutatud alusraam 	3	45x70	5900
IAR3	Foundation - Fundament - Fondation - Fondamenta - Fundering - Immutatud alusraam 	11	45x70	2893



Pos	Valga 6x5, Art.No.7014741 Piece list - Stückliste - Liste des pièces - Elementi - Stuklijst - Tükitalabel	Q	P (mm)	L (mm)
IAR2	Foundation - Fundament - Fondation - Fondamenta - Fundering - Immutatud alusraam 	2	45x70	2545
IAR1	Foundation - Fundament - Fondation - Fondamenta - Fundering - Immutatud alusraam 	2	45x70	2545
IAR4	Foundation - Fundament - Fondation - Fondamenta - Fundering - Immutatud alusraam 	12	45x70	1963
VT4	Mezzanine floor joists - Halbgeschoss balken - Solives de plancher mezzanine - Travi del pavimento mezzanino - Plaatduim scharnier - Vahelaetalad 	3	70x140	3360
VT5	Mezzanine floor joists - Halbgeschoss balken - Solives de plancher mezzanine - Travi del pavimento mezzanino - Plaatduim scharnier - Vahelaetalad 	3	70x140	2430
VT2	Mezzanine floor joists - Halbgeschoss balken - Solives de plancher mezzanine - Travi del pavimento mezzanino - Plaatduim scharnier - Vahelaetalad 	2	45x140	3360
VT3	Mezzanine floor joists - Halbgeschoss balken - Solives de plancher mezzanine - Travi del pavimento mezzanino - Plaatduim scharnier - Vahelaetalad 	2	45x140	2430
VT1	Mezzanine floor joists - Halbgeschoss balken - Solives de plancher mezzanine - Travi del pavimento mezzanino - Plaatduim scharnier - Vahelaetalad 	4	45x70	1930
PR1	Roof beam - Dachbalken - Panne de toit - Perlina del tetto - Gordingen / dakbalk - Põhipärilin 	1	70x140	5800
A-PR1	Roof beam - Dachbalken - Panne de toit - Perlina del tetto - Gordingen / dakbalk - Pärilin 	6	70x140	5800
HLL	Floor boards - Fussbodenbretter - Lame de plancher - Pavimento - Vloerhout - Põrandalaud 		137x28	321 m.
RB	Roof boards - Dachbretter - Voliges - Perlina per tetto - Dakhout - Katuselaud 	130	90x18	3500
FL	Floor fillet - Fussbodenleiste - Corniere de finition du plancher - Finitura per pavimento (battisco pa) - Vloerafwerklijs - Põrandaliist 		15x40	53 m.
M12	Treaded rod m12 - Gewindestange m12 - Tige filetée m12 - Barra filettata passo m12 - Draadstang 12m - Keermelatt 	6		445
M12	Treaded rod m12 - Gewindestange m12 - Tige filetée m12 - Barra filettata passo m12 - Draadstang 12m - Keermelatt 	6		2000
LPL	Fixing fillet - Fixierungsleiste - Profil de fixation - Massello di fissaggio - Bevestiging lijstwerk - Tenderliist 	2	18x70	791
LPL	Fixing fillet - Fixierungsleiste - Profil de fixation - Massello di fissaggio - Bevestiging lijstwerk - Tenderliist 	4	18x70	1933
SWE1	Doorstep - Swelle - Seuil de porte - Callare - Drempe - Lävepakkeukseavale 	1	28x74	840
TB	Fascia board - Traufbrett - Bandeau de toit - Finitura lati tetto - Gevellijst - Räästalaud 	4	18x90	2900
DRV	Roof edge reinforcement - Dachrandverstärkung - Corniere de renfort de bord de toit - Rinforzo x tetto - Dakrand versterking - Räästatugevdus 	4	28x34	2900
TBE6	Fixing fillet - Fixierungsleiste - Profil de fixation - Massello di fissaggio - Bevestiging lijstwerk - Tenderliist 	6	28x34	748
TBE6	Fixing fillet - Fixierungsleiste - Profil de fixation - Massello di fissaggio - Bevestiging lijstwerk - Tenderliist 	2	28x34	916
TBE6	Fixing fillet - Fixierungsleiste - Profil de fixation - Massello di fissaggio - Bevestiging lijstwerk - Tenderliist 	6	28x34	1923

Pos	Valga 6x5, Art.No.7014741 Piece list - Stückliste - Liste des pièces - Elementi - Stuklijst - Tükítabel	Q	P (mm)	L (mm)
KL4	Lengthening bolt for threaded rod - Verlängerungsmutter für gewindestange - Manchon de raccordement de tige filetée - Bullone per barra filettata passo - Extensie moer voor draadstang - Jätikumutter keermelatfile 	6		
KL1	Drive nut threaded rod - Einschlagmutter für gewindestange - Écrou a frapper pour tige filitée - Dado guida per barra filettata - Aandrijfmoer / aanslagmoer voor draadstang - Löökmutter keermelatfile 	6		
KL2	Nut for threaded rod - Mutter für gewindestange - Écrou pour tige filetée - Dado per barra filettata - Moer voor draadstang - Mutter keermelatfile 	6		
KL3	Plain washer threaded rod - Unterlegscheibe für gewindestange - Rondelle plate pour tige filetée - Rondella per barra filettata - Sluiring voor draadeind - Seib keermelatfile 	6		
HS12	Screw for gable segment - Schrauben für deckblatt - Vis pour fixation losange de finition - Viti x frontali tetto - Schroef voor gevelpunt segment - Kruvi rombile 	4	3.5x35	
HS83	Screw for fixing fillet of door and window - Schrauben für fixierungsleiste - Vis pour profil vertical de fixation pour ouvertures des fenetres et portes - Viti per massello di fissaggio - Schroeven voor bevestiging van deur en raam lijsten - Kruvi tenderliistudele 	26	3.5x50	
HS25	Screw for floor - Schrauben für fussbodenbretter - Vis pour plancher - Viti per le perline del pavimento - Schroef voor vloerhout - Kruvi põrandale 	1100	3.5x50	
HS84	Screw for fixing fillet of door and window - Schrauben für fixierungsleiste - Vis pour profil vertical de fixation pour ouvertures des fenetres et portes - Viti per massello di fissaggio - Schroeven voor bevestiging van deur en raam lijsten - Kruvi tenderliistudele 	62	3.5x50	
HS16	Screw for gable moulding - Schrauben für giebelleiste - Vis pour fixation planche de rive - Vite per fissare finiture davanti e dietro del tetto - Schroef voor gevellijst - Kruvi viilulauale 	40	3.5x50	
HS32	Screw for fascia boards - Schrauben für traufbretter - Vis pour fixation bandeau de toit - Viti x striscia del tetto - Schroef voor gevellijst - Kruvi räästalauale 	28	4x40	
HS26	Screw for roof edge reinforcement - Schrauben für dachrandverstärkung - Vis pour fixation corniere renfort de bord de toit - Viti x rinforzo bordo tetto - Schroef voor dakrand versterking - Kruvi räästatugevdusele 	28	4x40	
HS36	Screw for stepladder - Schraube für leiter - Vis d'assemblage des marches de l'échelle - Vite per scaletta - Schroef voor trapladder - Kruvi redeli montaažiks 	36	4x40	
HS89	Screw for loft support - Schraube für dachbefestigung - Vis pour cornière de renfort de fixation - Viti per supporto del soppalco - Schroef voor dakbevestiging - Kruvi vahelae kandurliistule 	72	5x100	
HS40	Screw for 1. wall beam - Schraube für 1. bohlenreihe - Vis de fixations 1ere rangée de madriers avec poutrelles de fondations - Vite fissaggio alle fondamenta - Schroef voor 1 wandbalk - Kruvi poollauale 	18	5x120	
HS42	Screw for gable - Schrauben für giebel - Vis pour fixation des pignons - Viti per timpano - Schroef voor gevelpunt - Kruvi viilude kinnitamiseks 	48	5x120	
HS43	Screw for roof beams - Schrauben für dachbalken - Vis pour fixation pannes de toit - Viti per perline del tetto - Schroef voor gordingen / dakbalken - Kruvi pärlinitele 	21	5x120	
HS39	Screw for foundation - Schrauben zur befestigung fundament - Vis de fixations des poutrelles de fondations - Viti x fondamenta - Schroef voor fundering - Kruvi alusraamile 	66	5x90	
MS	Screw for doorstep - Schrauben für swelle - Vis pour fixation barre de seuil - Vite per soglia della porta - Schroef voor deurdorpel - Kruvi lävepakule 	7	4.5x65	
SH70	Hammer block - Schlagholz - Calle de frappe - Blocco di legno da usare come cuscinetto quando si usa il martello - Slagklos - Löögiklots 	2		
NFD	Zn nail for roofing felt fillet - Zn nagel für dachpappenleiste - Pointe pour baguette de fixation feutre bitumeux - Chiodi x carta bituminosa x tetto - Spijker(nagel) voor asfaltpapier afdekljst - Papiliistunael 	36	2x40	
NFF	Zn nail for floor fillet - Zn nagel für fussbodenleiste - Pointe pour corniere de finition du plancher - Chiodi x fissaggio pavimento - Spijker(nagel) voor vloer afdekljst - Nael põrandaliistule 	106	1.4x40	
NF2	Zn nail for roof - Zn nagel für dachbretter - Pointe pour fixation voliges de toit - Chiodi x perline tetto - Spijker(nagel) voor dakhout - Nael katuselauale 	686	2.1x50	
ORZ	Montage set for doors and windows - Montage set für türen und fenster - Jeu de montage portes et fenetres - Set di assemblaggio per porte e finestre - Montage set voor deur en raam - Orthez akna ja ukse montaaživahendid	1		

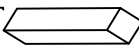
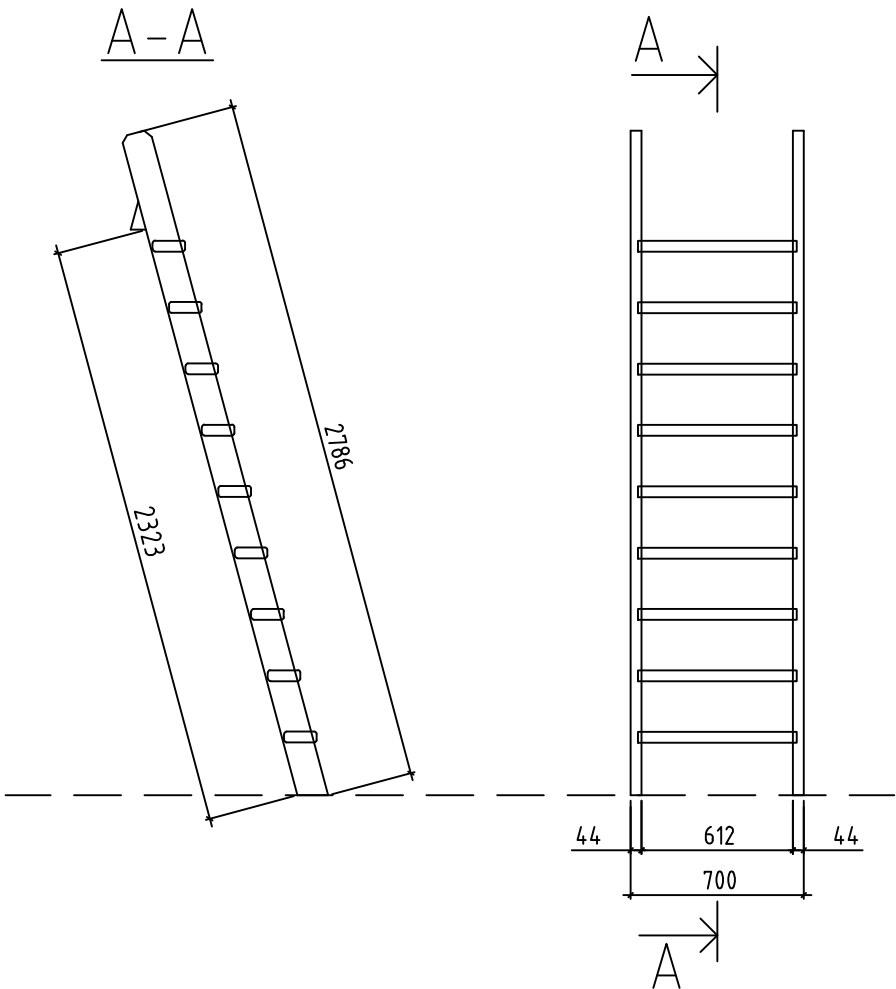
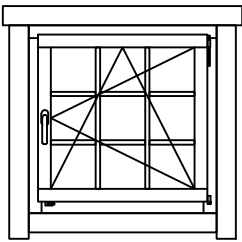
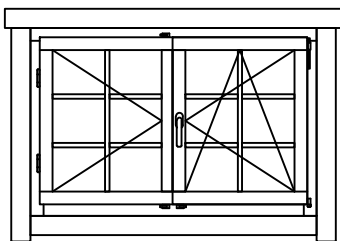
Pos	Valga 6x5, Art.No.7014741 Piece list - Stückliste - Liste des pièces - Elementi - Stuklijst - Tükítabel	Q	P (mm)	L (mm)
GS	Gable segment - Deckblatt - Losange de finition - Decorazione in legno x frontale tetto - Gevelpunt segment - Romb 	2		
SP	Hidden fixing - Holzdübel - Tourillon bois - Fissaggio a scomparsa - Verloren kop spijker - Salapulk 	25		
LR	Ladder - Leiter - Echelle - Scala a pioli - Ladder - Redel  	1		
	Window - Fenster - Fenetre - Finestra - Raam - Aken  	3	916x916 2+ A.9P.K	
	Window - Fenster - Fenetre - Finestra - Raam - Aken  	1	1374x916 2+ TA.6P.K	

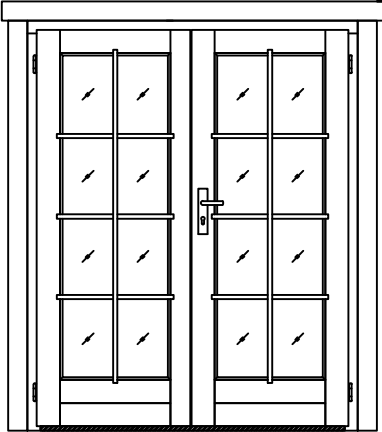
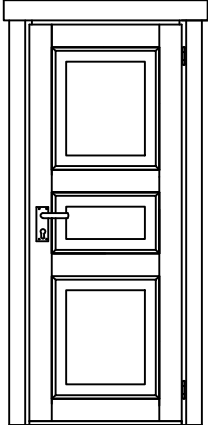
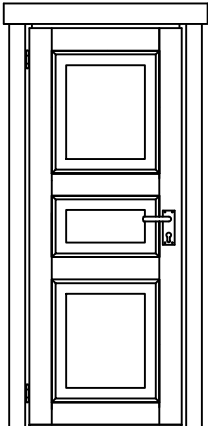
Pos	Valga 6x5, Art.No.7014741 Piece list - Stückliste - Liste des pièces - Elementi - Stuklijst - Tükitabel	Q	P (mm)	L (mm)
	Door - Tür - Porte - Porte - Deur - Uks 1580x1933 2+ TU.18P.K 	1		
	Door - Tür - Porte - Porte - Deur - Uks +LPL 827x1933 U.3TP 	1		
	Door - Tür - Porte - Porte - Deur - Uks +LPL 827x1933 U.3TV 	1		

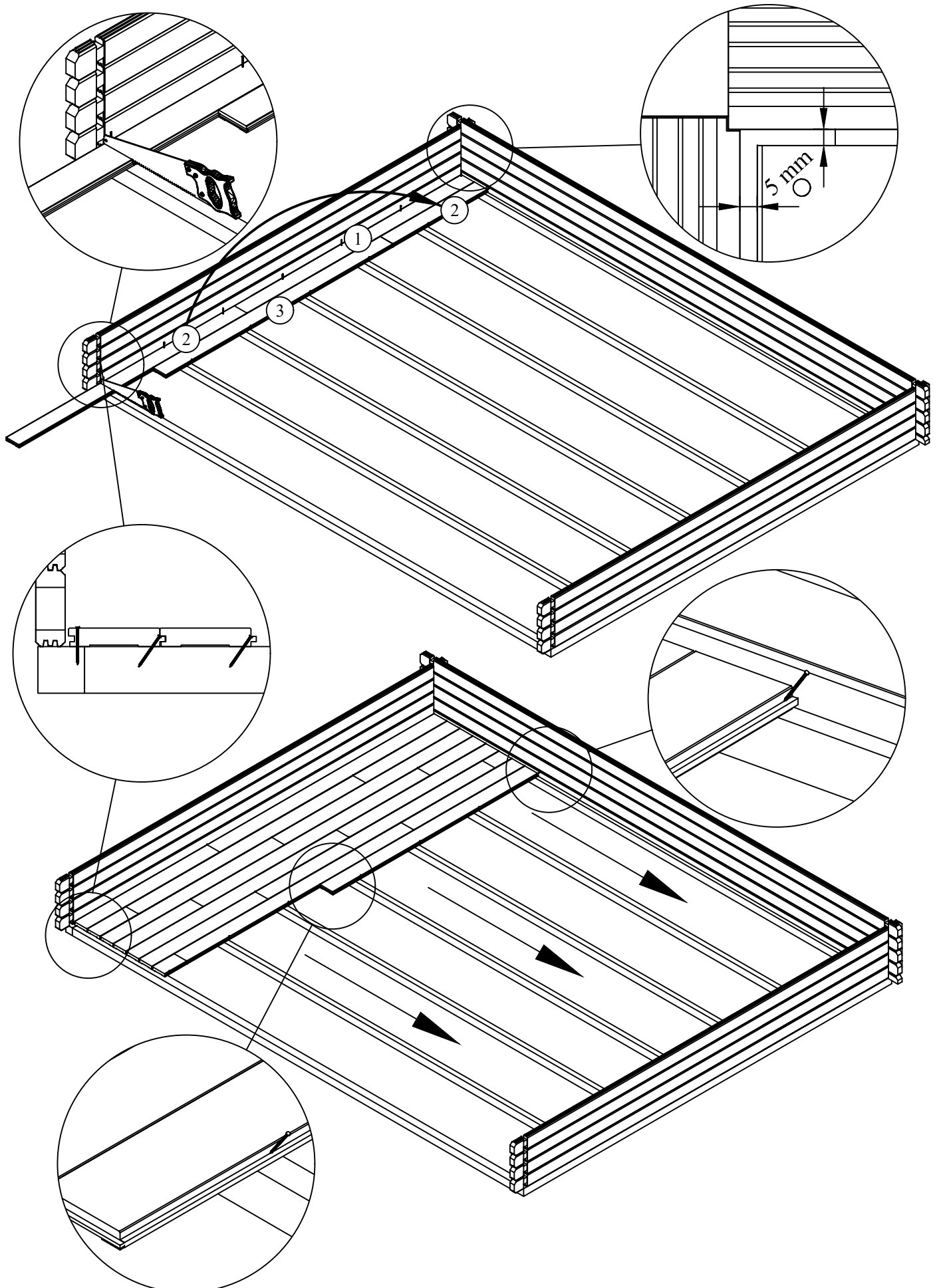

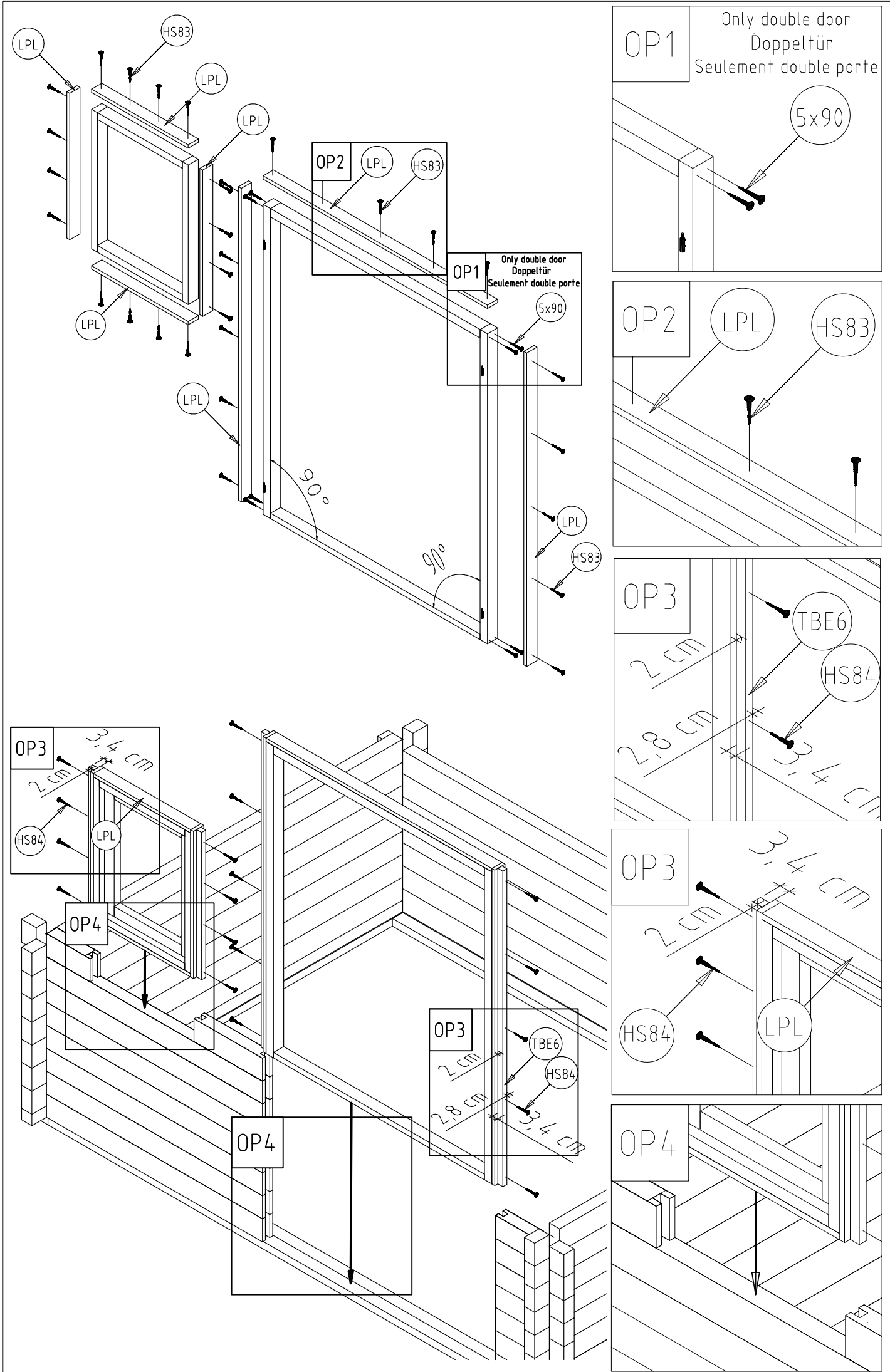

OP1 Only double door  
Doppeltür  
Seulement double porte

5x90

OP2 LPL HS83

OP3 TBE6 HS84

OP3 LPL HS84

OP4

LPL HS83 LPL LPL LPL

OP2 LPL HS83

OP1 Only double door  
Doppeltür  
Seulement double porte

5x90

90°

90°

OP3 LPL HS84

3,4 cm  
2 cm

OP4

OP3 TBE6 HS84

2 cm  
2.8 cm  
3,4 cm

OP4

OP4

