

*Valga 7x7*  
Art.No. 7014841

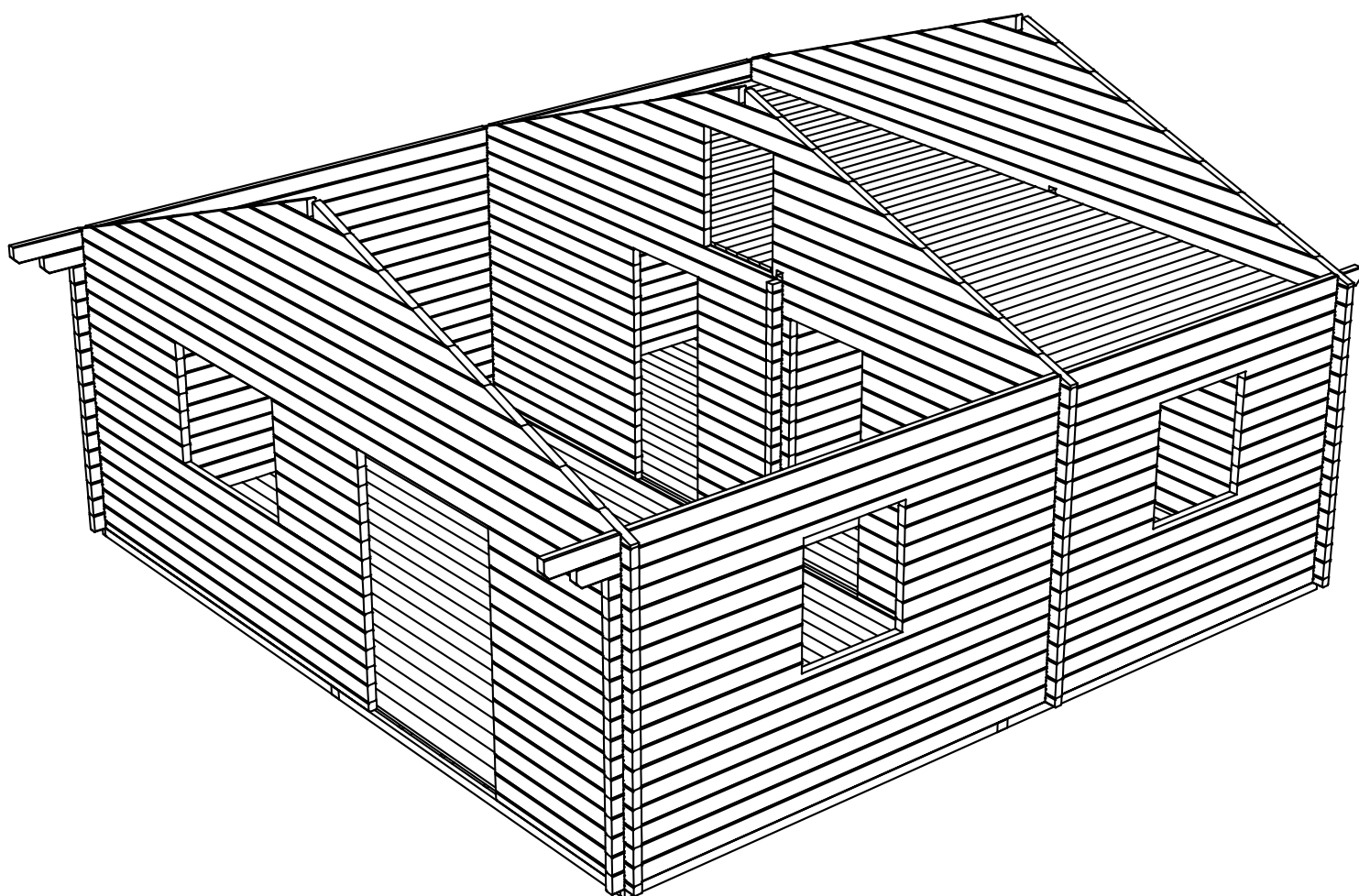

Valga 7x7, Art.No.7014841  
Groundplan - Grundplan - Plan de masse - Planimetria - Plattegrond - Põhiplaan

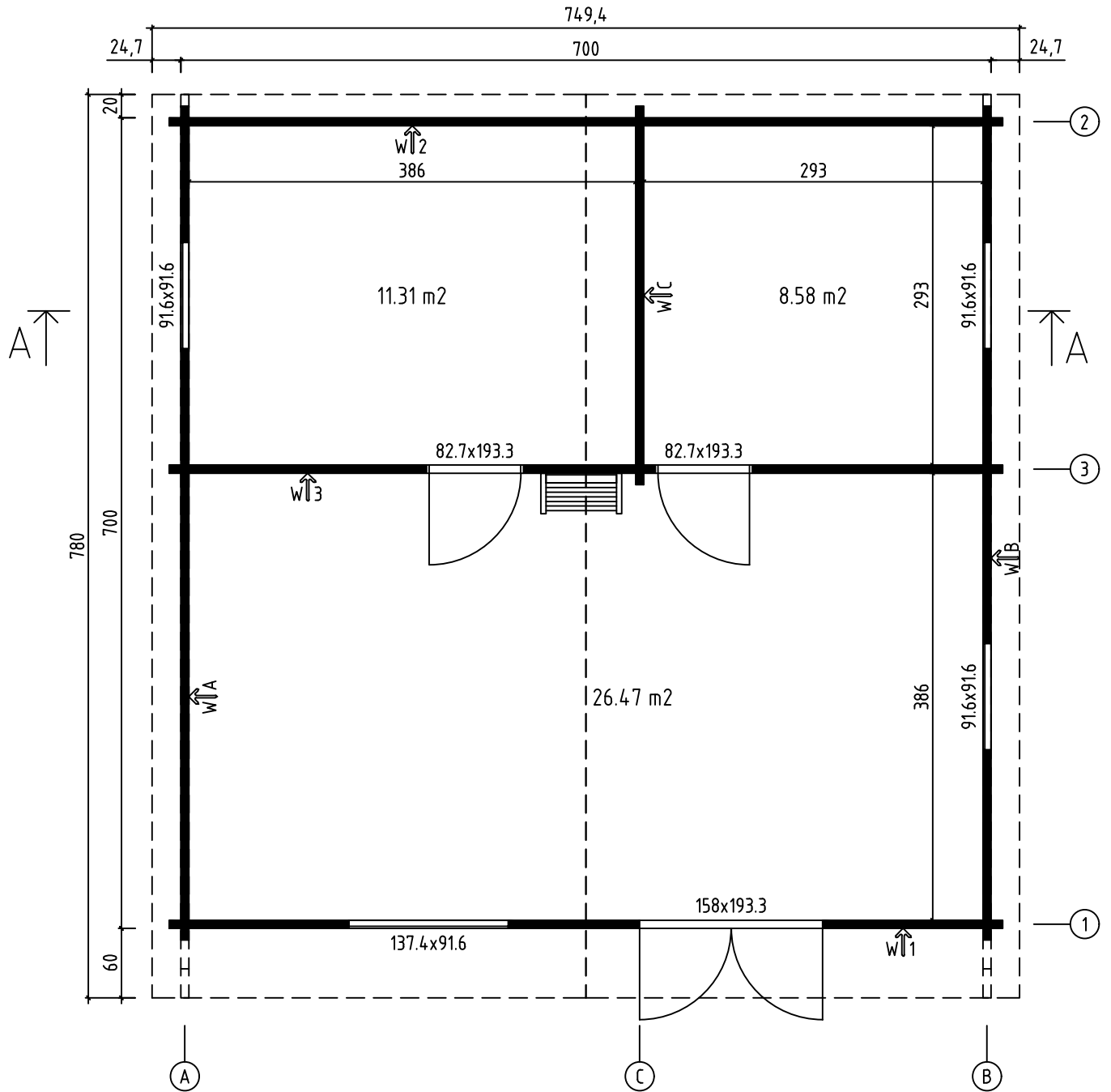

Valga 7x7, Art.No.7014841  
Groundplan - Grundplan - Plan de masse - Planimetria - Plattegrond - Põhiplaan

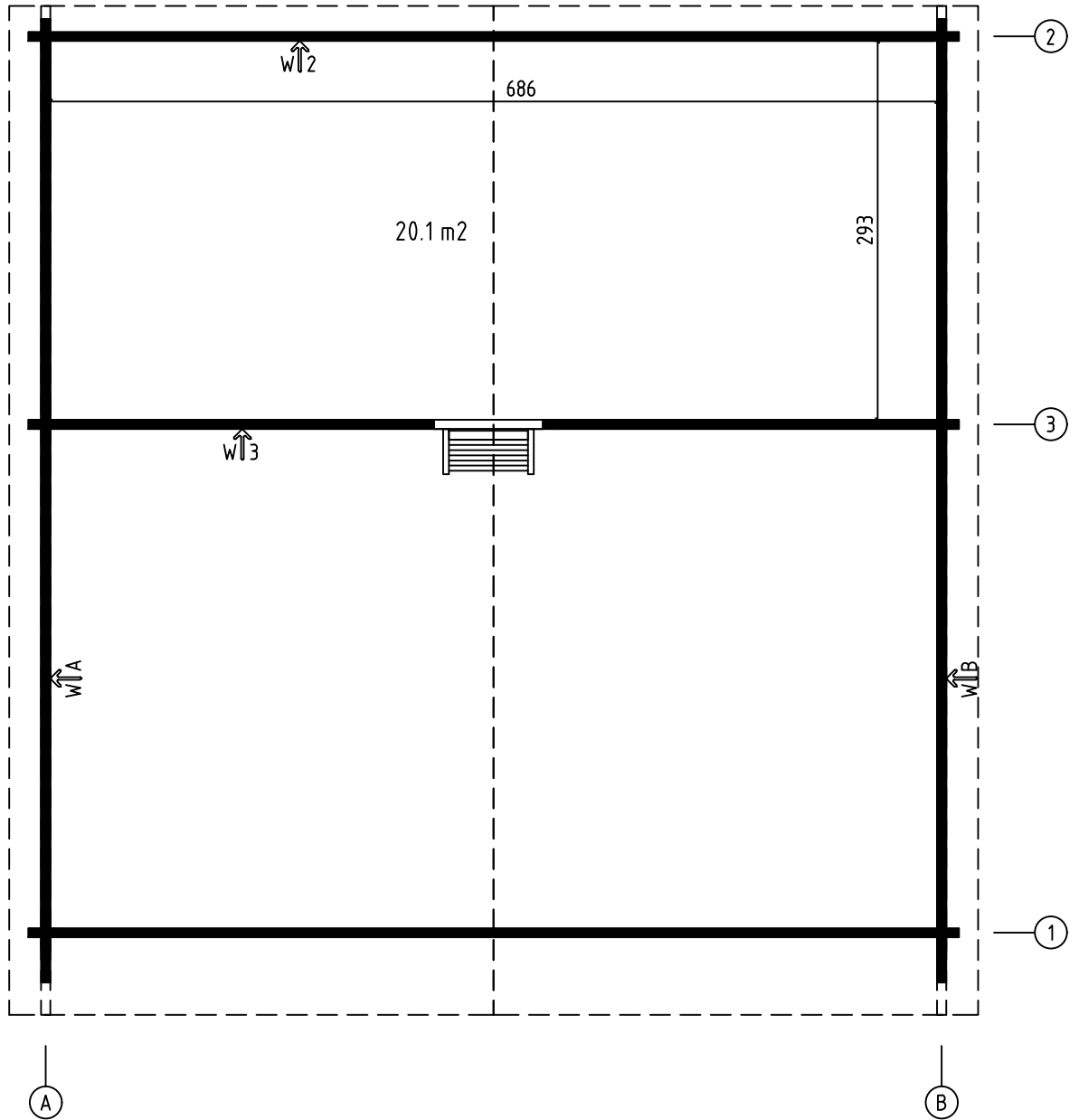

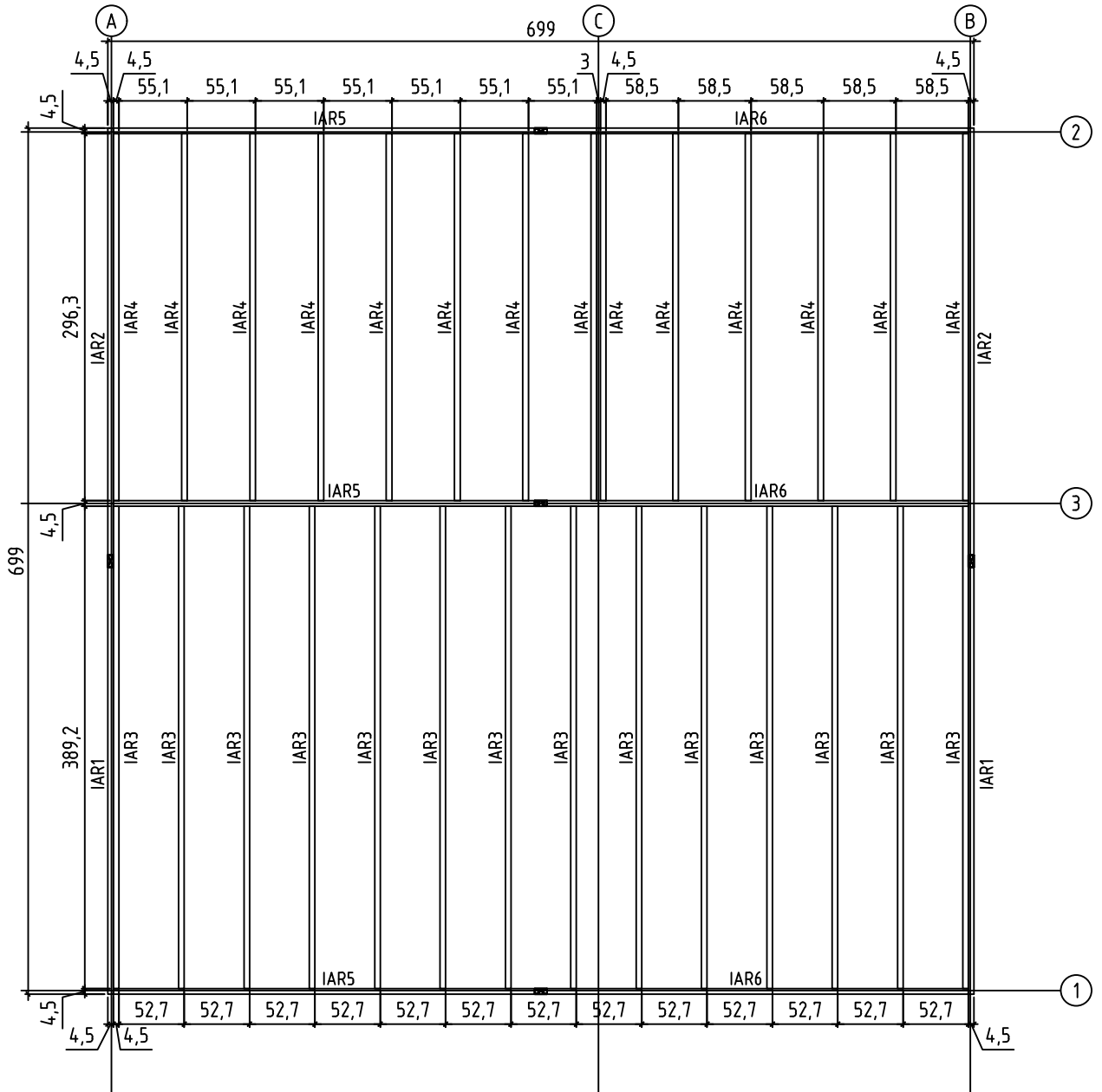

Valga 7x7, Art.No.7014841

Mezzanine floor joists - Halbgeschoss balken - Solives de plancher mezzanine - Travi del pavimento mezzanino - Plaatduim scharnier - Vahelaetalad

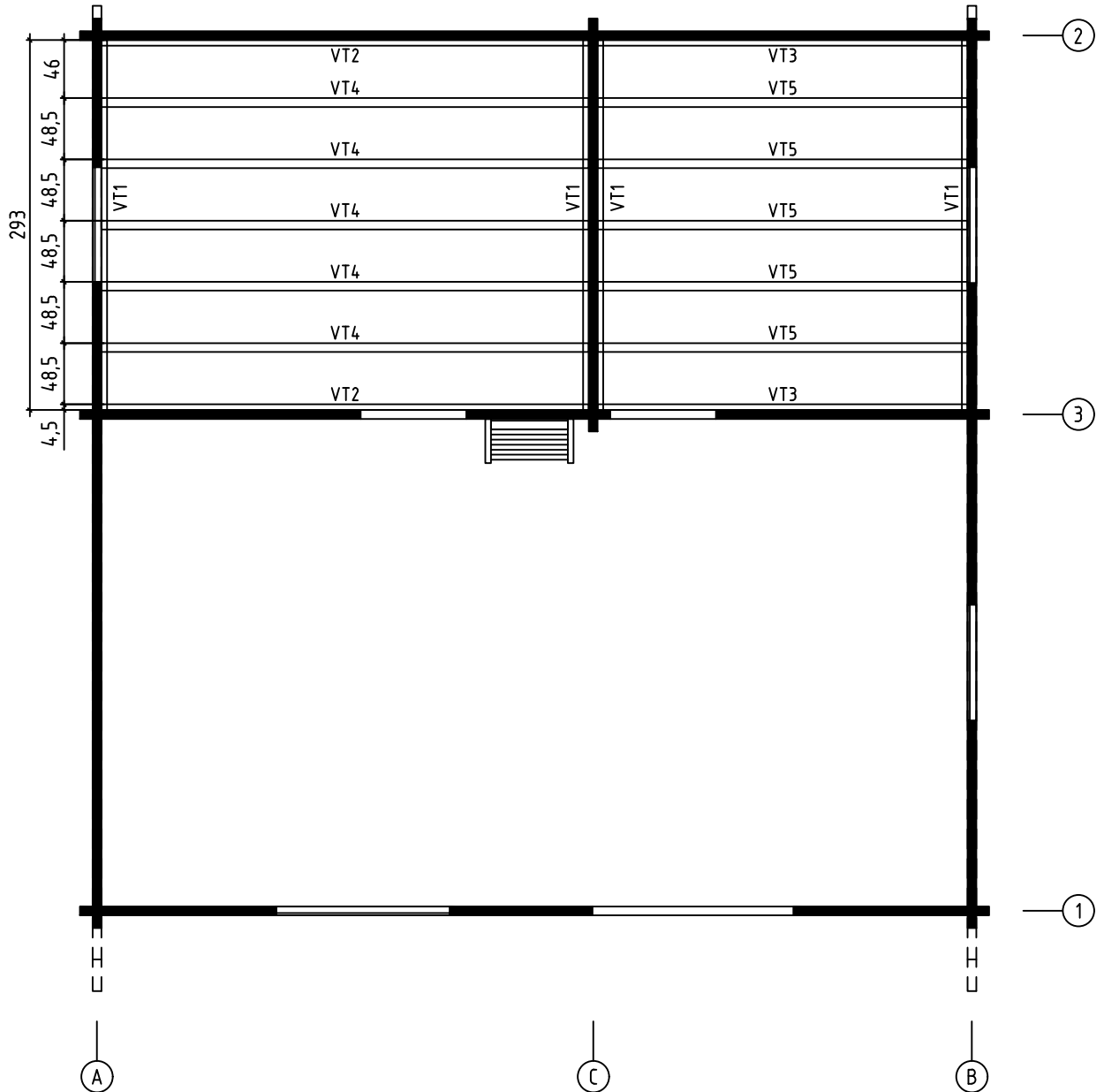

Valga 7x7, Art.No.7014841  
Floor boards - Fussbodenbretter - Plan pose plancher - Pavimento - Vloerhout -  
Põrandalaudis

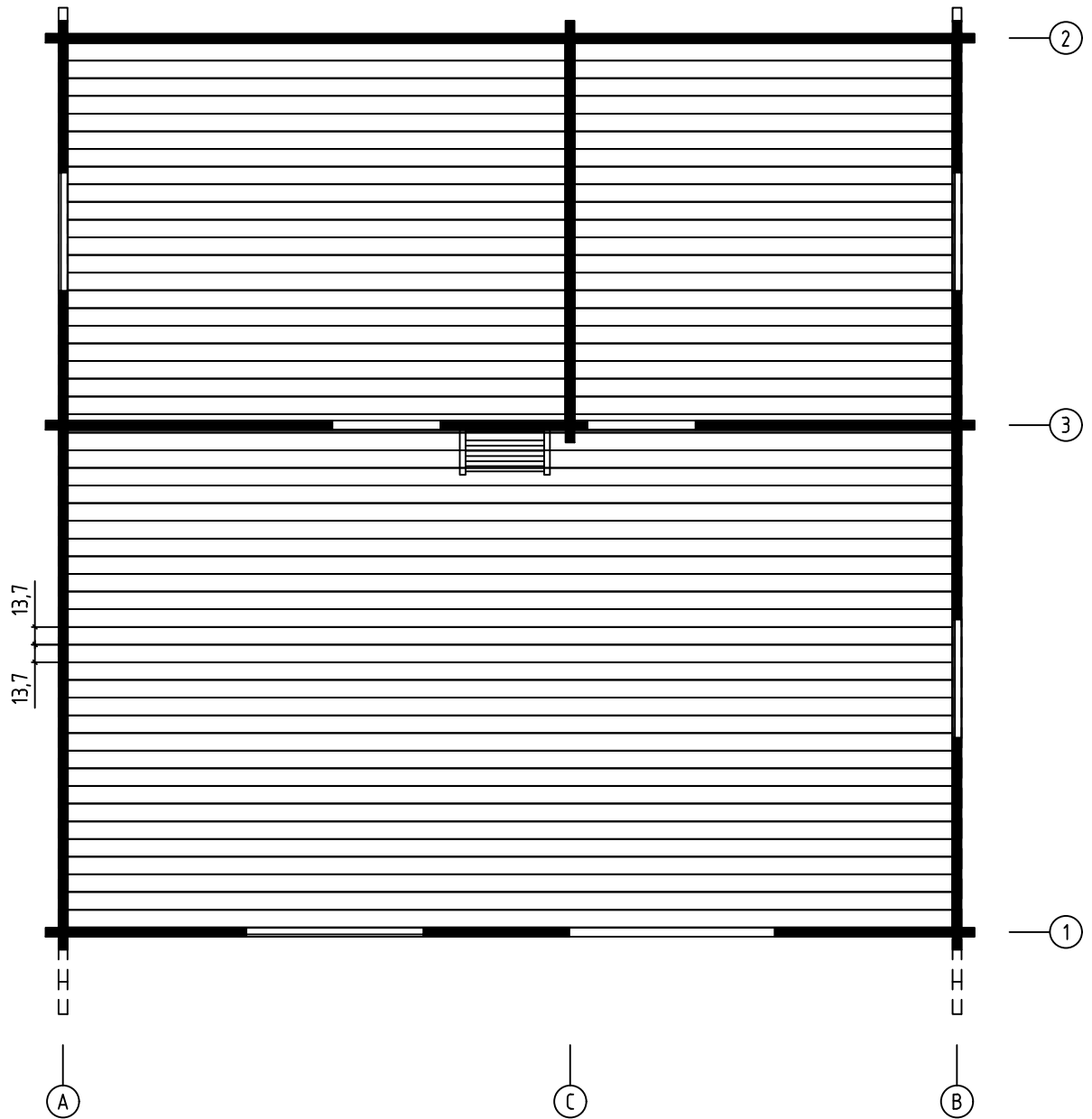

Valga 7x7, Art.No.7014841  
Floor boards - Fussbodenbretter - Plan pose plancher - Pavimento - Vloerhout -  
Põrandalaudis

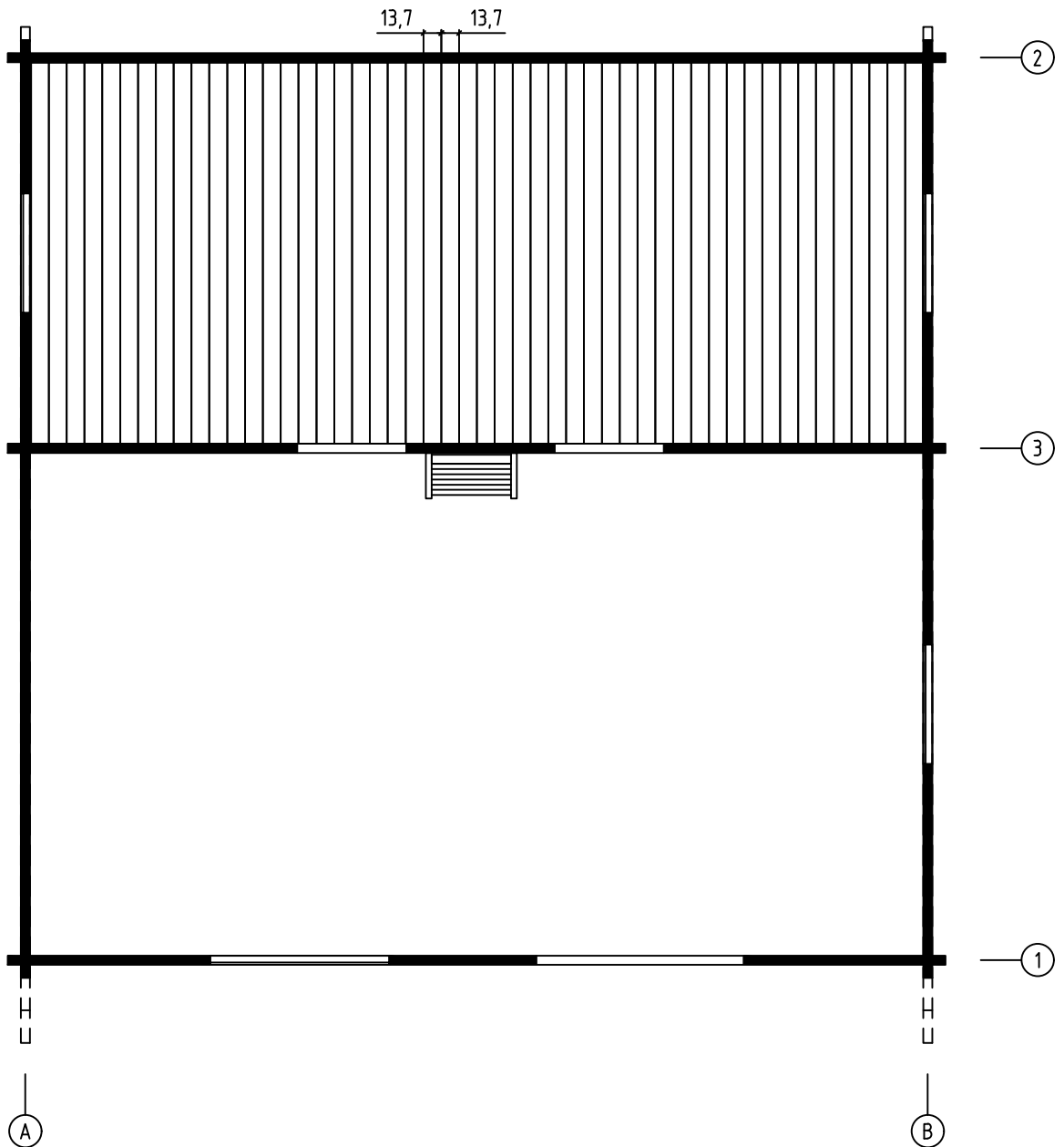

Valga 7x7, Art.No.7014841

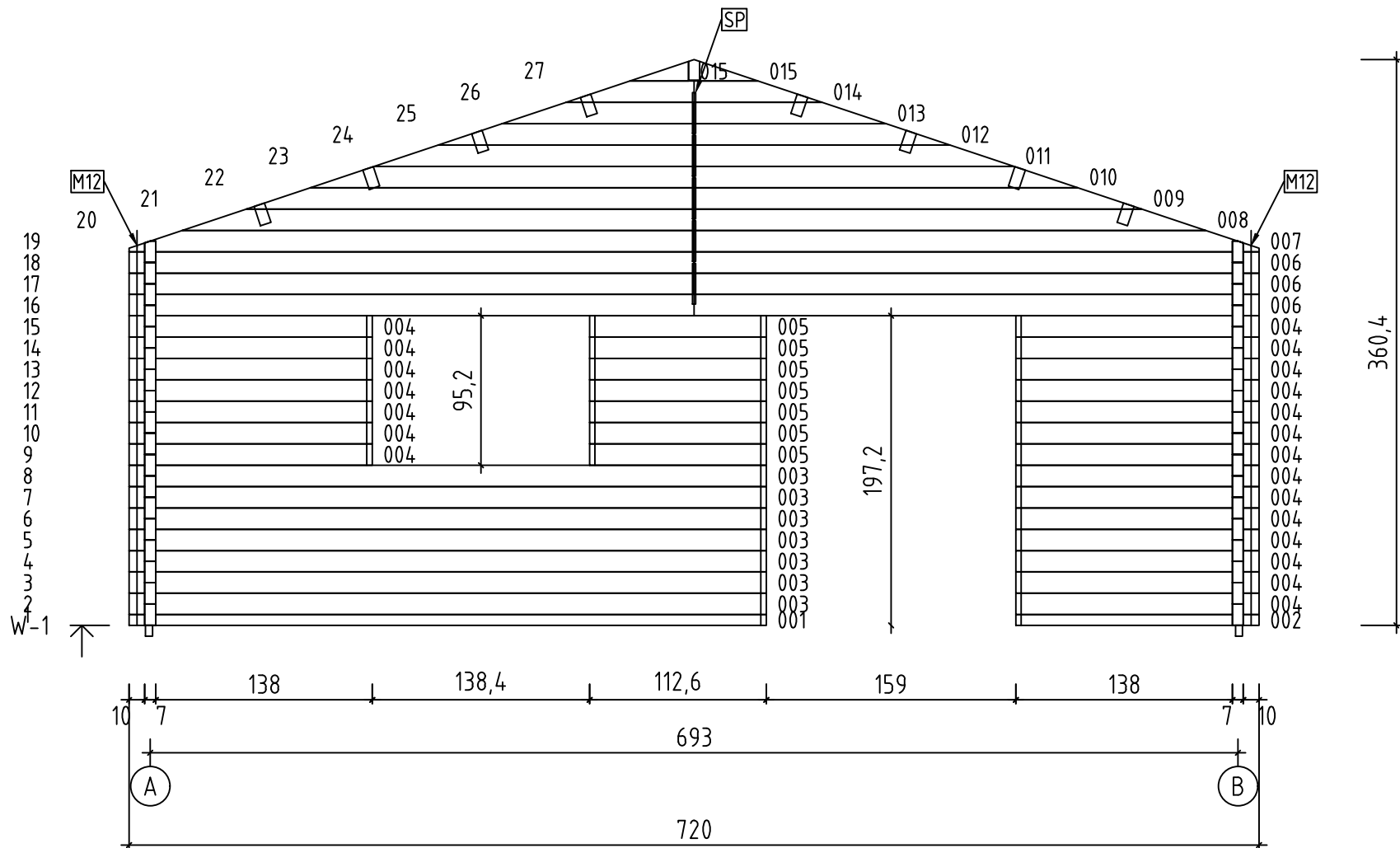



Valga 7x7, Art.No.7014841

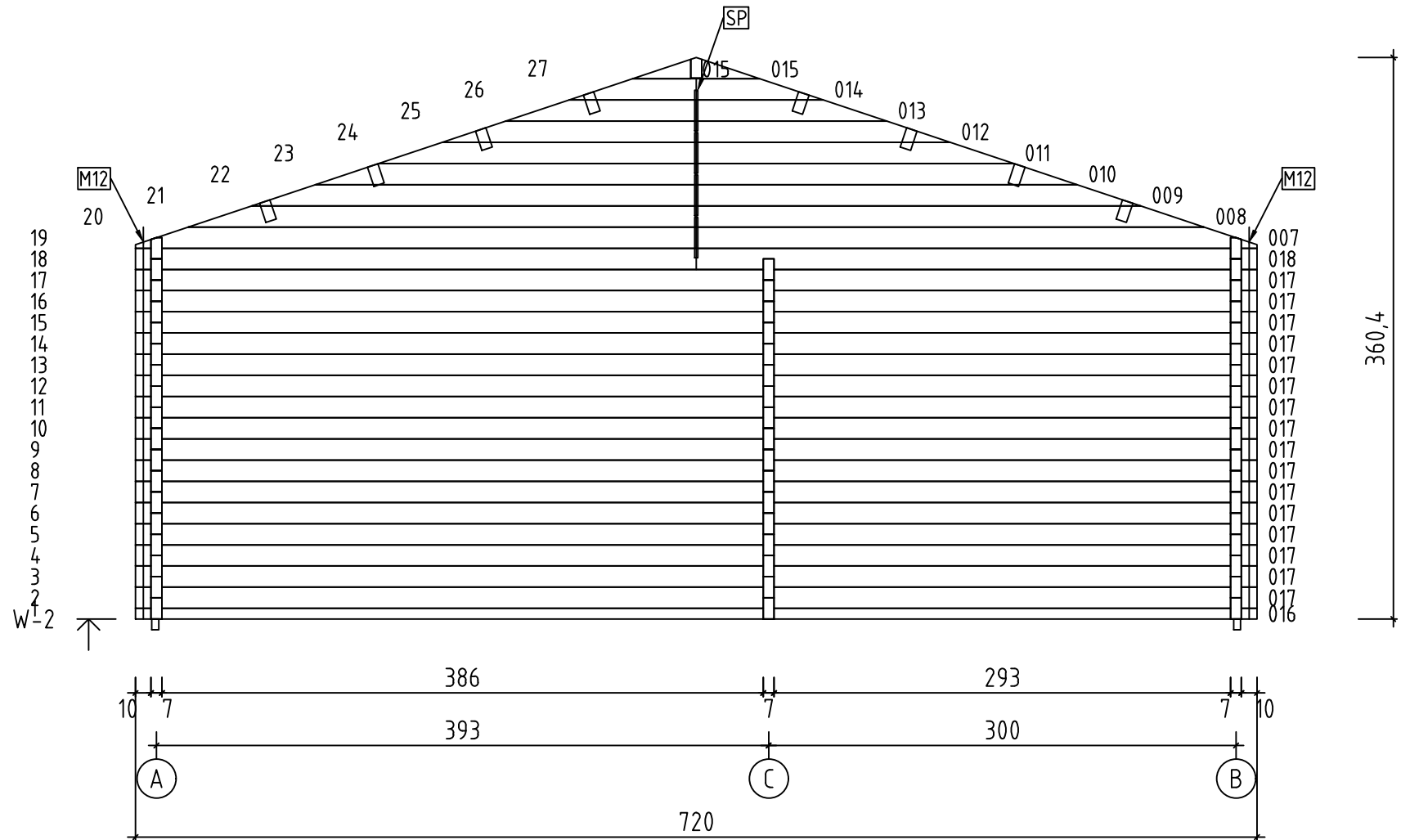

Valga 7x7, Art.No.7014841

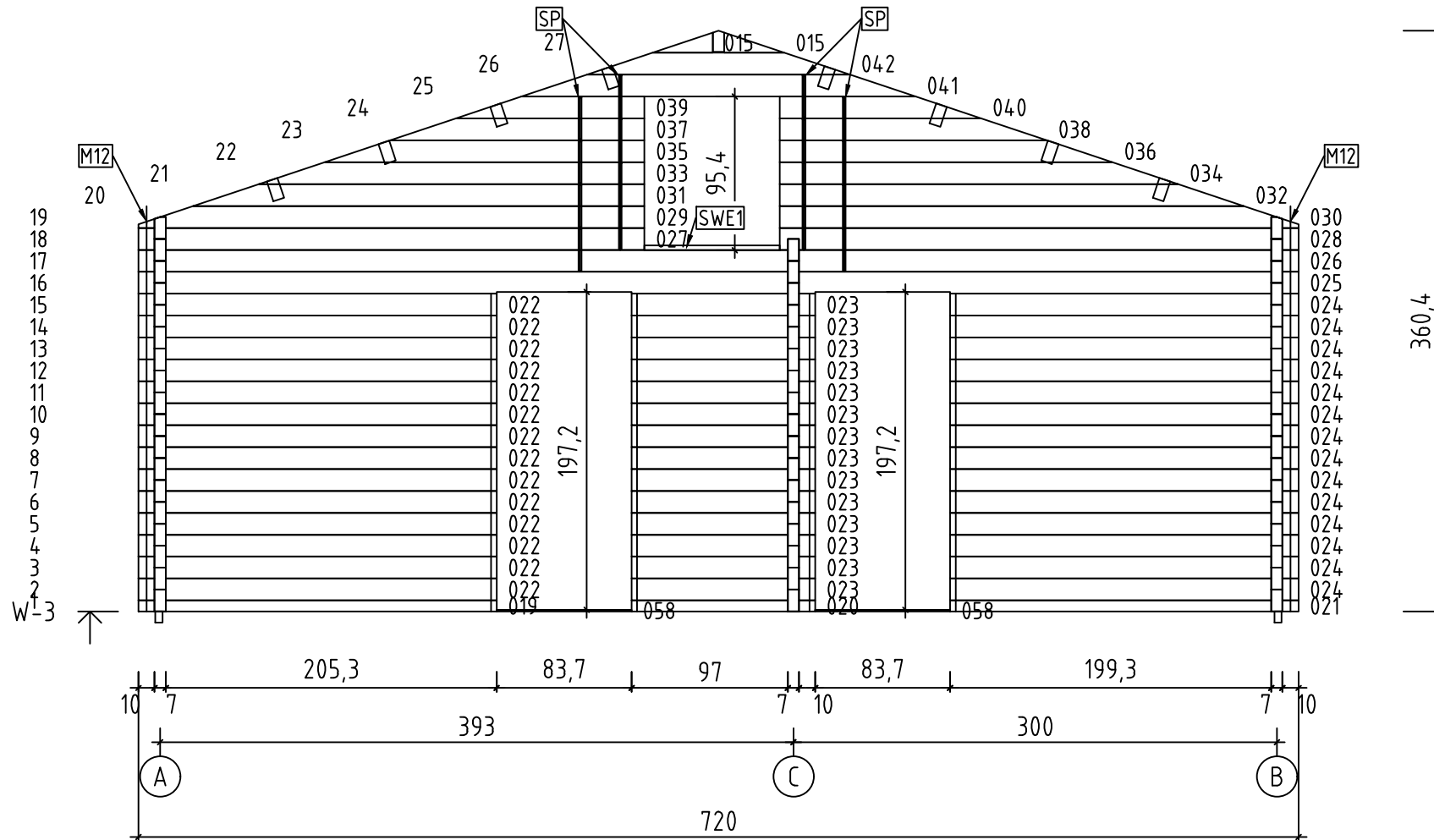

Valga 7x7, Art.No.7014841

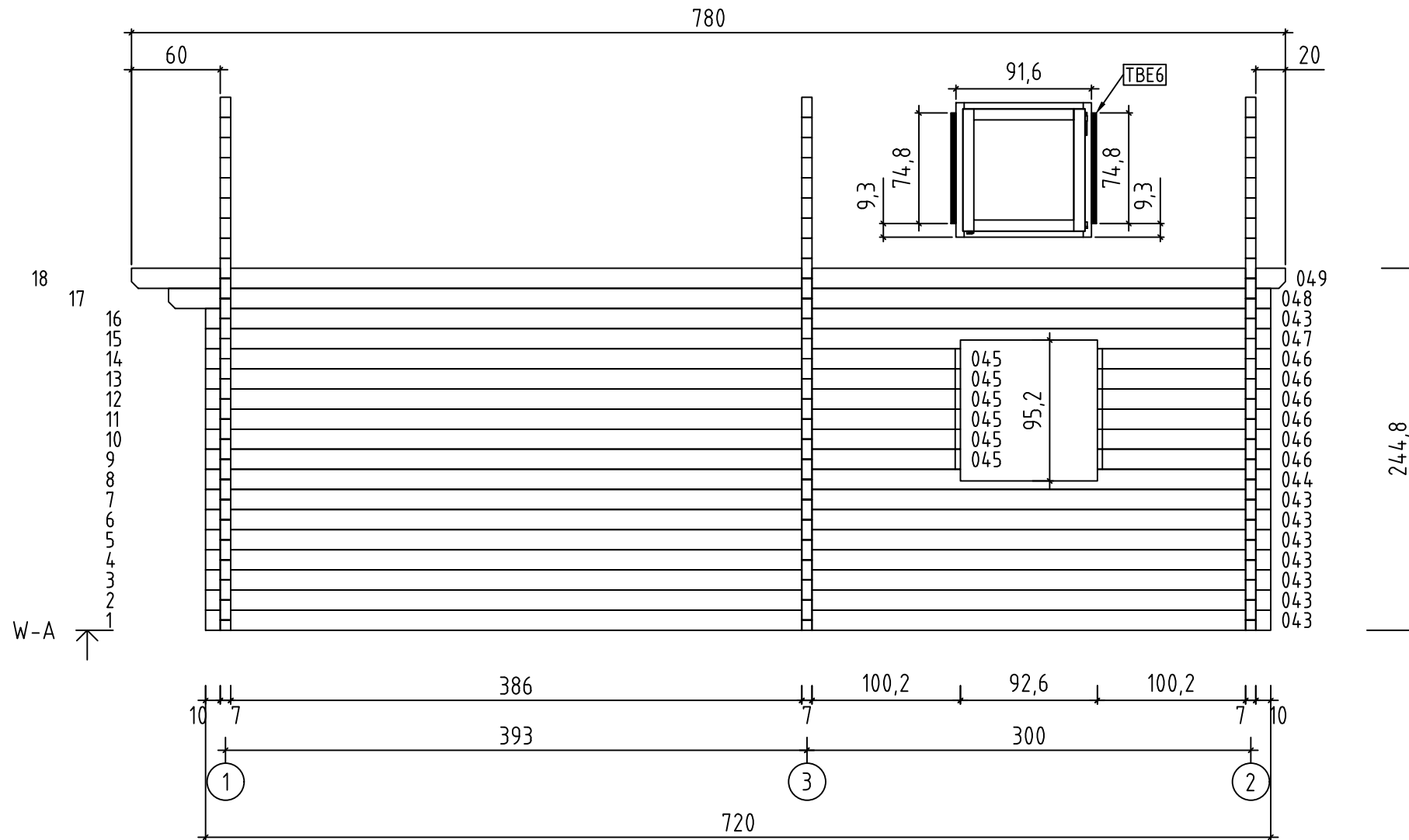

Valga 7x7, Art.No.7014841

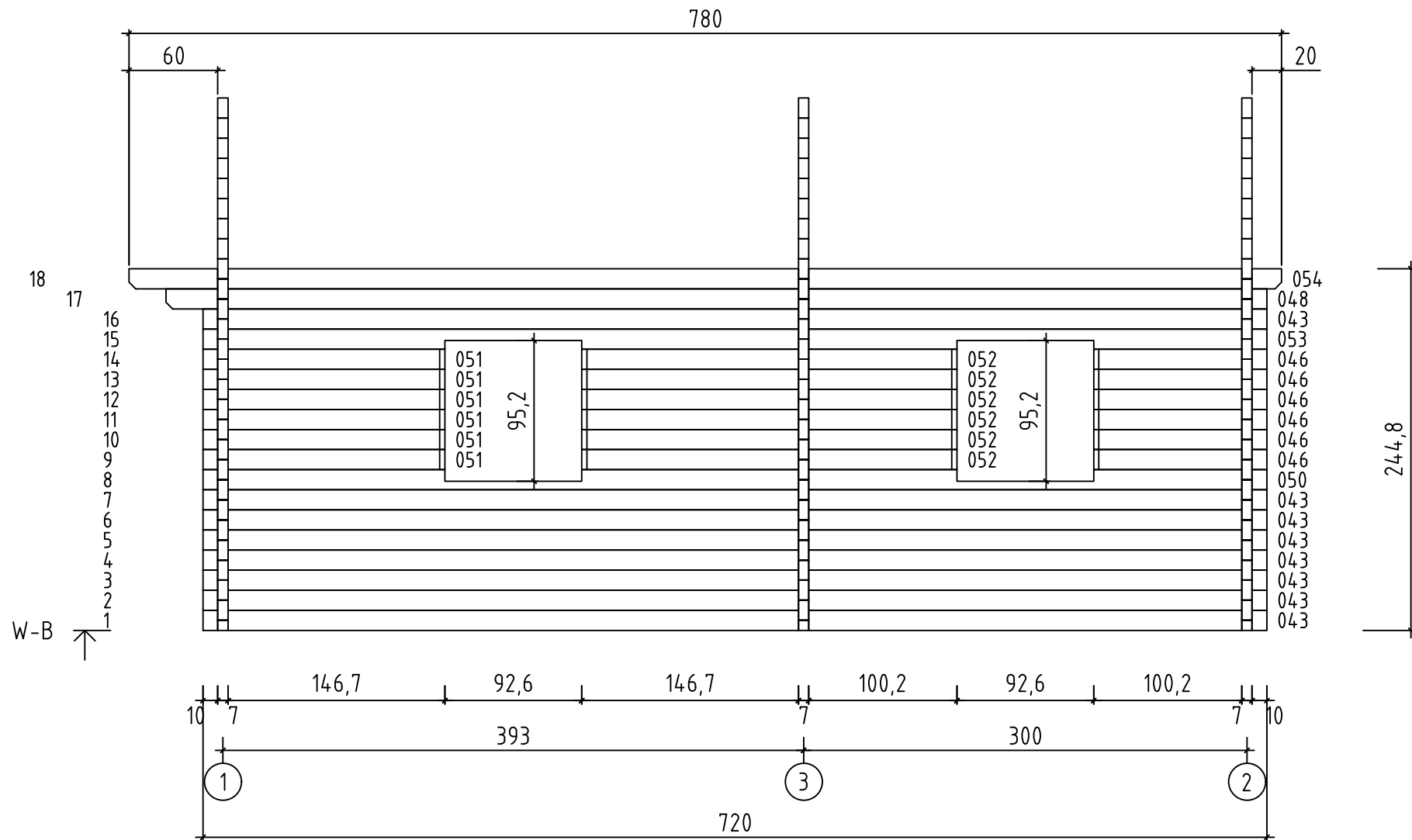



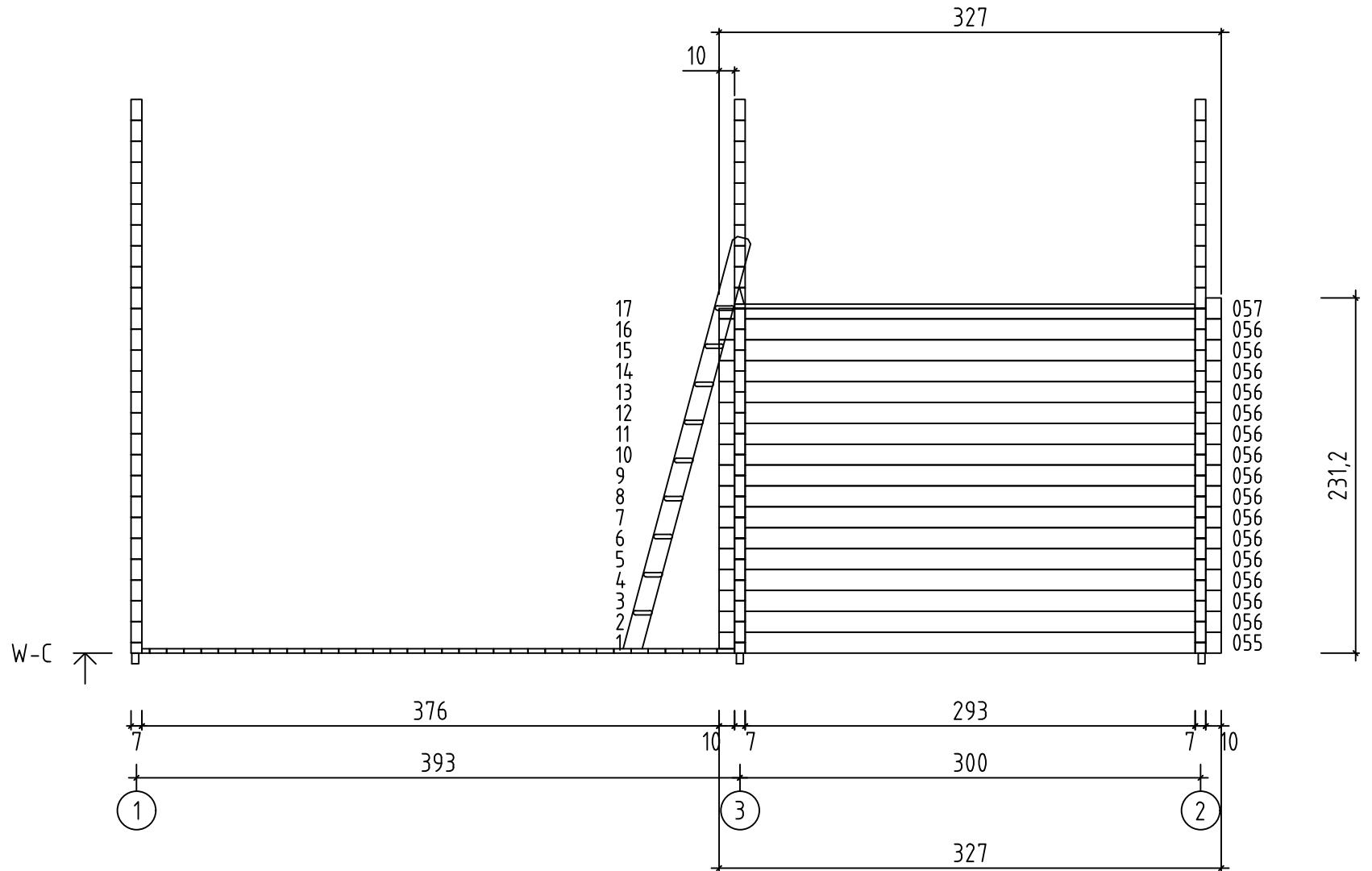

Valga 7x7, Art.No.7014841

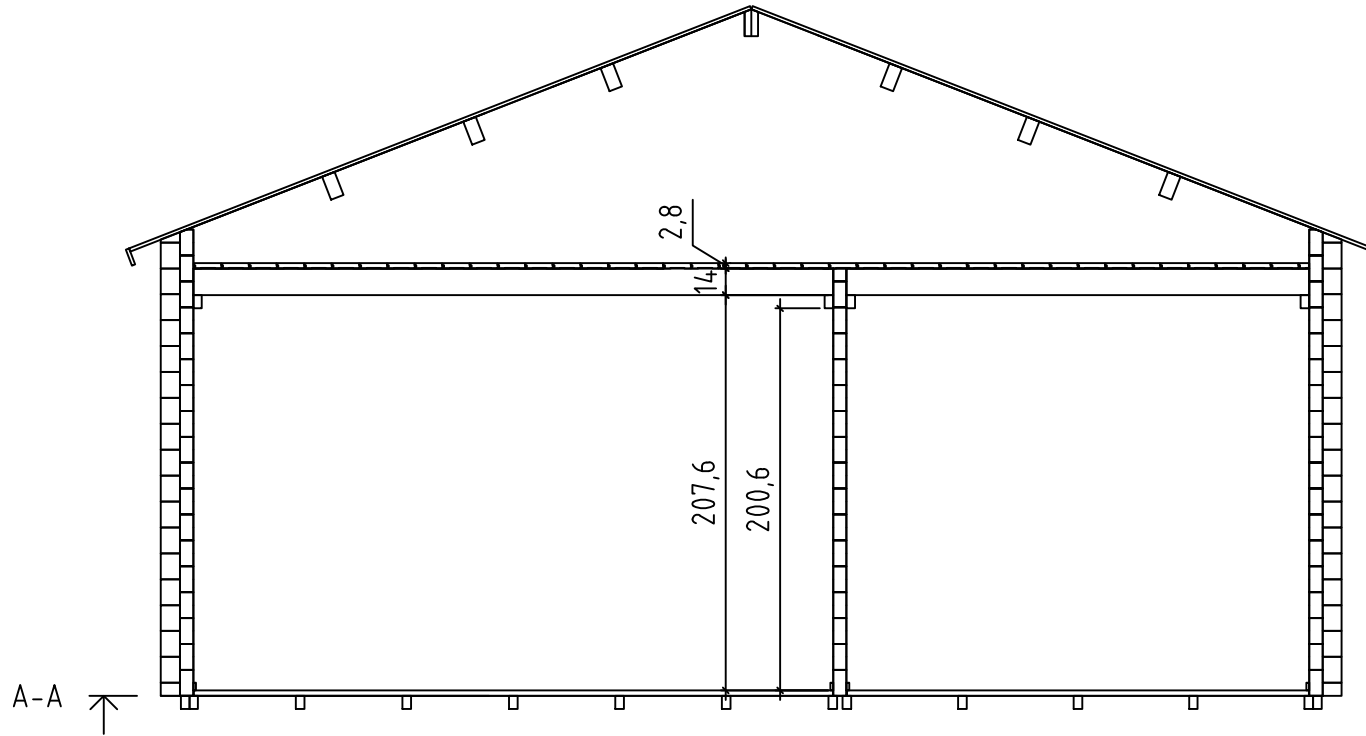

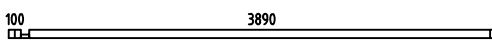
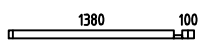
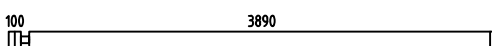
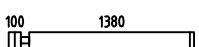
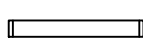
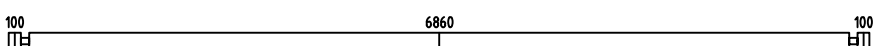
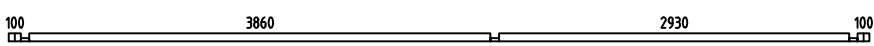
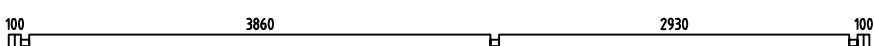
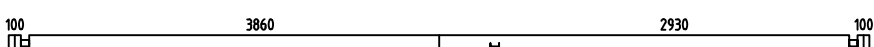
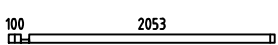
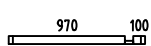
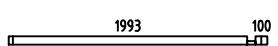
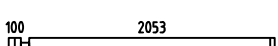
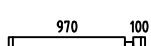
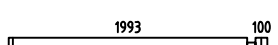
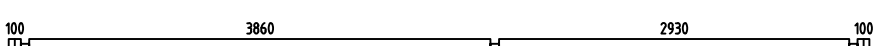
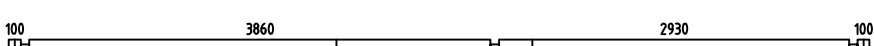
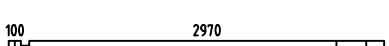
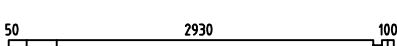
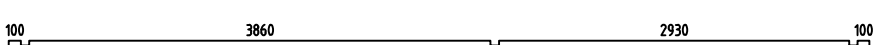

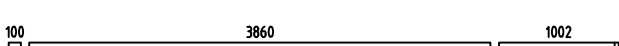
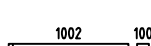

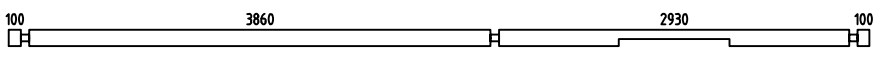
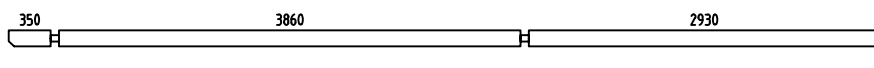
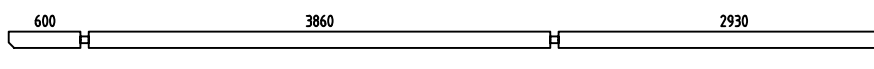
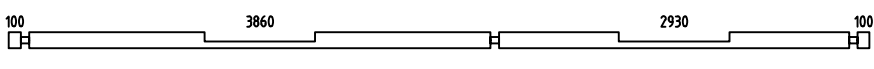
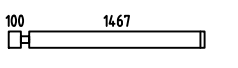
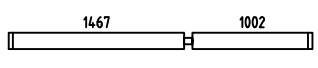
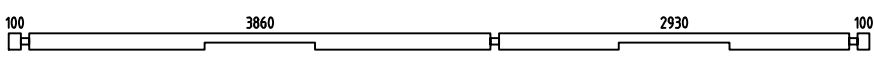
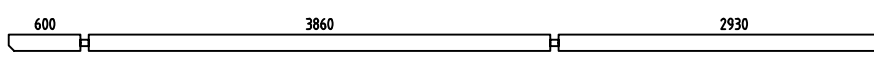
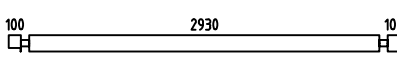
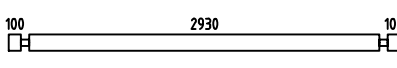
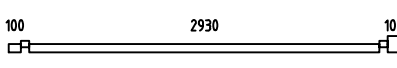

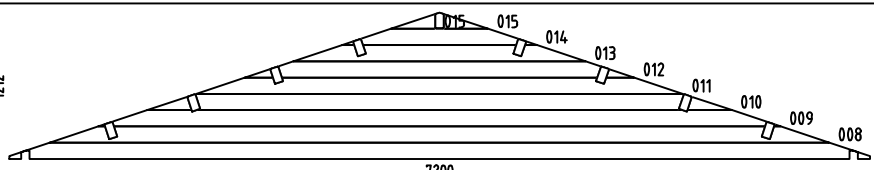
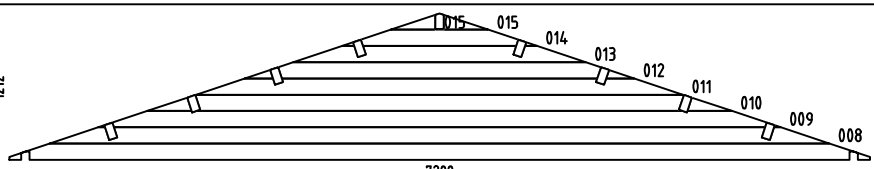
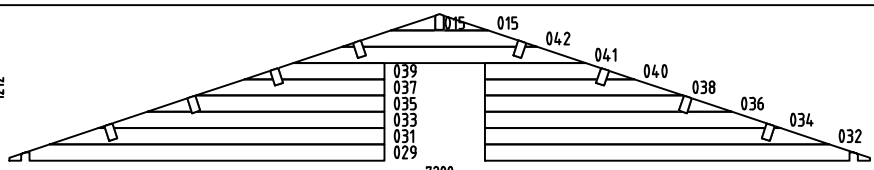
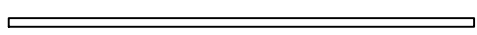
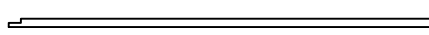
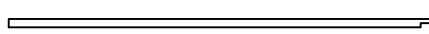
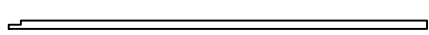
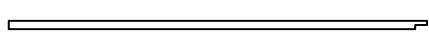









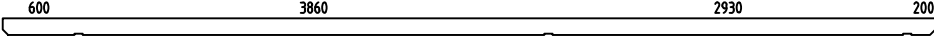
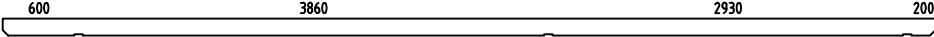



Valga 7x7, Art.No.7014841

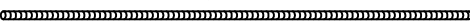



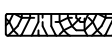



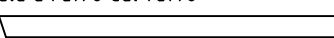















Pos	Valga 7x7, Art.No.7014841 Piece list - Stückliste - Liste des pièces - Elementi - Stuklijst - Tükitabel	Q	P (mm)	L (mm)
001		1	70x68	4060
002		1	70x68	1550
003		7	70x136	4060
004		21	70x136	1550
005		7	70x136	1126
006		3	70x136	7200
016		1	70x68	7200
017		16	70x136	7200
018		1	70x136	7200
019		1	70x68	2223
020		1	70x68	1140
021		1	70x68	2163
022		14	70x136	2223
023		14	70x136	1140
024		14	70x136	2163
025		1	70x136	7200
026		1	70x136	7200
027		1	70x136	3140
028		1	70x136	3220
043		16	70x136	7200
044		1	70x136	7200
045		6	70x136	5102
046		12	70x136	1172

Pos	Valga 7x7, Art.No.7014841 Piece list - Stückliste - Liste des pièces - Elementi - Stuklijst - Tükital	Q	P (mm)	L (mm)
047		1	70x136	7200
048		2	70x136	7450
049		1	70x136	7800
050		1	70x136	7200
051		6	70x136	1637
052		6	70x136	2539
053		1	70x136	7200
054		1	70x136	7800
055		1	70x136	3270
056		15	70x136	3270
057		1	70x136	3270
058		2	70x10	837
W1-1		1		
W2-1		1		
W3-1		1		
IAR3	Foundation - Fundament - Fondation - Fondamenta - Fundering - Immutatud alusraam 	14	45x70	3893
IAR2	Foundation - Fundament - Fondation - Fondamenta - Fundering - Immutatud alusraam 	2	45x70	3545
IAR1	Foundation - Fundament - Fondation - Fondamenta - Fundering - Immutatud alusraam 	2	45x70	3545
IAR6	Foundation - Fundament - Fondation - Fondamenta - Fundering - Immutatud alusraam 	3	45x70	3500
IAR5	Foundation - Fundament - Fondation - Fondamenta - Fundering - Immutatud alusraam 	3	45x70	3500



Pos	Valga 7x7, Art.No.7014841 Piece list - Stückliste - Liste des pièces - Elementi - Stuklijst - Tükitalabel	Q	P (mm)	L (mm)
IAR4	Foundation - Fundament - Fondation - Fondamenta - Fundering - Immutatud alusraam 	14	45x70	2963
VT4	Mezzanine floor joists - Halbgeschoss balken - Solives de plancher mezzanine - Travi del pavimento mezzanino - Plaatduim scharnier - Vahelaetalad 	5	70x140	3860
VT5	Mezzanine floor joists - Halbgeschoss balken - Solives de plancher mezzanine - Travi del pavimento mezzanino - Plaatduim scharnier - Vahelaetalad 	5	70x140	2930
VT2	Mezzanine floor joists - Halbgeschoss balken - Solives de plancher mezzanine - Travi del pavimento mezzanino - Plaatduim scharnier - Vahelaetalad 	2	45x140	3860
VT3	Mezzanine floor joists - Halbgeschoss balken - Solives de plancher mezzanine - Travi del pavimento mezzanino - Plaatduim scharnier - Vahelaetalad 	2	45x140	2930
VT1	Mezzanine floor joists - Halbgeschoss balken - Solives de plancher mezzanine - Travi del pavimento mezzanino - Plaatduim scharnier - Vahelaetalad 	4	45x70	2930
PR1	Roof beam - Dachbalken - Panne de toit - Perlina del tetto - Gordingen / dakbalk - Põhipärtlin 	1	70x140	7800
A-PR1	Roof beam - Dachbalken - Panne de toit - Perlina del tetto - Gordingen / dakbalk - Pärtlin 	8	70x140	7800
HLL	Floor boards - Fussbodenbretter - Lame de plancher - Pavimento - Vloerhout - Põrandalaud 		137x28	547 m.
RB	Roof boards - Dachbretter - Voliges - Perlina per tetto - Dakhout - Katuselaud 	174	90x18	3950
FL	Floor fillet - Fussbodenleiste - Corniere de finition du plancher - Finitura per pavimento (battisco pa) - Vloerafwerklijs - Põrandaliist 		15x40	67 m.
DPL-1	Roofing felt fillet - Dachpappenleiste - Baguette de fixation du feutre bitumeux - Asse per fissaggio guaina bituminosa - Afdeklijs asfaltpapier - Katusepapiiist 	4	18x58	3950
M12	Treaded rod m12 - Gewindestange m12 - Tige filetée m12 - Barra filettata passo m12 - Draadstang 12m - Keermelatt 	6		445
M12	Treaded rod m12 - Gewindestange m12 - Tige filetée m12 - Barra filettata passo m12 - Draadstang 12m - Keermelatt 	6		2000
LPL	Fixing fillet - Fixierungsleiste - Profil de fixation - Massello di fissaggio - Bevestiging lijstwerk - Tenderliist 	2	18x70	791
LPL	Fixing fillet - Fixierungsleiste - Profil de fixation - Massello di fissaggio - Bevestiging lijstwerk - Tenderliist 	4	18x70	1933
SWE1	Doorstep - Swelle - Seuil de porte - Callare - DrempeL - Lävepak ukseavale 	1	28x74	840
TB	Fascia board - Traufbrett - Bandeau de toit - Finitura lati tetto - Gevellijst - Räästalaud 	4	18x90	3900
DRV	Roof edge reinforcement - Dachrandverstärkung - Corniere de renfort de bord de toit - Rinforzo x tetto - Dakrand versterking - Räästafugevdus 	4	28x34	3900
TBE6	Fixing fillet - Fixierungsleiste - Profil de fixation - Massello di fissaggio - Bevestiging lijstwerk - Tenderliist 	6	28x34	748
TBE6	Fixing fillet - Fixierungsleiste - Profil de fixation - Massello di fissaggio - Bevestiging lijstwerk - Tenderliist 	2	28x34	916
TBE6	Fixing fillet - Fixierungsleiste - Profil de fixation - Massello di fissaggio - Bevestiging lijstwerk - Tenderliist 	6	28x34	1923
GL	Gable moulding - Giebelleiste - Planche de rive - Finitura per frontale e retro del tetto - Gevellijst - Viilulaud 	4	18x120	3950

Pos	Valga 7x7, Art.No.7014841 Piece list - Stückliste - Liste des pièces - Elementi - Stuklijst - Tükitalabel	Q	P (mm)	L (mm)
KL4	Lengthening bolt for threaded rod - Verlängerungsmutter für gewindestange - Manchon de raccordement de tige filetée - Bullone per barra filettata passo - Extensie moer voor draadstang - Jätkumutter keermelatäle 	6		
KL1	Drive nut threaded rod - Einschlagmutter für gewindestange - Écrou a frapper pour tige filitée - Dado guida per barra filettata - Aandrijfmoer / aanslagmoer voor draadstang - Löökmutter keermelatäle 	6		
KL2	Nut for threaded rod - Mutter für gewindestange - Écrou pour tige filetée - Dado per barra filettata - Moer voor draadstang - Mutter keermelatäle 	6		
KL3	Plain washer threaded rod - Unterlegscheibe für gewindestange - Rondelle plate pour tige filetée - Rondella per barra filettata - Sluistring voor draadeind - Seib keermelatäle 	6		
HS12	Screw for gable segment - Schrauben für deckblatt - Vis pour fixation losange de finition - Viti x frontali tetto - Schroef voor gevelpunt segment - Krugi rombäle 	4	3.5x35	
HS83	Screw for fixing fillet of door and window - Schrauben für fixirungsteiste - Vis pour profil vertical de fixation pour ouvertures des fenetres et portes - Viti per massello di fissaggio - Schroeven voor bevestiging van deur en raam lijsten - Krugi tenderlijstudele 	26	3.5x50	
HS25	Screw for floor - Schrauben für fussbodenbretter - Vis pour plancher - Viti per le perline del pavimento - Schroef voor vloerhout - Krugi põrandale 	1300	3.5x50	
HS84	Screw for fixing fillet of door and window - Schrauben für fixirungsteiste - Vis pour profil vertical de fixation pour ouvertures des fenetres et portes - Viti per massello di fissaggio - Schroeven voor bevestiging van deur en raam lijsten - Krugi tenderlijstudele 	62	3.5x50	
HS16	Screw for gable moulding - Schrauben für giebelleiste - Vis pour fixation planche de rive - Vite per fissare finiture davanti e dietro del tetto - Schroef voor gevellijst - Krugi viilulauale 	48	3.5x50	
HS32	Screw for fascia boards - Schrauben für traufbretter - Vis pour fixation bandeau de toit - Viti x striscia del tetto - Schroef voor gevellijst - Krugi räästalauale 	36	4x40	
HS26	Screw for roof edge reinforcement - Schrauben für dachrandverstärkung - Vis pour fixation corniere renfort de bord de toit - Viti x rinforzo bordo tetto - Schroef voor dakrand versterking - Krugi räästatugevdusele 	36	4x40	
HS36	Screw for stepladder - Schraube für leiter - Vis d'assemblage des marches de l'échelle - Vite per scaletta - Schroef voor trapladder - Krugi redeli montaažiks 	36	4x60	
HS89	Screw for loft support - Schraube für dachbefestigung - Vis pour corniere de renfort de fixation - Viti per supporto del soppalco - Schroef voor dakbevestiging - Krugi vahelae kandurlijstule 	80	5x100	
HS40	Screw for 1. wall beam - Schraube für 1. bohlenreihe - Vis de fixations 1ere rangée de madriers avec poutrelles de fondations - Vite fissaggio alle fondamenta - Schroef voor 1 wandbalk - Krugi poollauale 	21	5x120	
HS42	Screw for gable - Schrauben für giebel - Vis pour fixation des pignons - Viti per timpano - Schroef voor gevelpunt - Krugi viilude kinnitamiseks 	48	5x120	
HS43	Screw for roof beams - Schrauben für dachbalken - Vis pour fixation pannes de toit - Viti per perline del tetto - Schroef voor gordingen / dakbalken - Krugi pärlinitäle 	27	5x120	
HS39	Screw for foundation - Schrauben zur befestigung fundament - Vis de fixations des poutrelles de fondations - Viti x fondamenta - Schroef voor fundering - Krugi alusraamäle 	82	5x90	
MS	Screw for doorstep - Schrauben für swelle - Vis pour fixation barre de seuil - Vite per soglia della porta - Schroef voor deurdorpel - Krugi lävepakule 	7	4.5x65	
SH70	Hammer block - Schlagholz - Calle de frappe - Blocco di legno da usare come cuscinetto quando si usa il martello - Slagklos - Löögiklots 	2		
NFD	Zn nail for roofing felt fillet - Zn nägel für dachpappenleiste - Pointe pour baguette de fixation feutre bitumeux - Chiodi x carta bituminosa x tetto - Spijker(nagel) voor asfaltpapier afdekljst - Papiliistunael 	44	2x40	
NFF	Zn nail for floor fillet - Zn nägel für fussbodenleiste - Pointe pour corniere de finition du plancher - Chiodi x fissaggio pavimento - Spijker(nagel) voor vloer afdekljst - Nael põrandaliistule 	150	1.4x40	
NF2	Zn nail for roof - Zn nägel für dachbretter - Pointe pour fixation voliges de toit - Chiodi x perline tetto - Spijker(nagel) voor dakhout - Nael katuselauale 	1090	2.1x50	
ORZ	Montage set for doors and windows - Montage set für türen und fenster - Jeu de montage portes et fenetres - Set di assemblaggio per porte e finestre - Montage set voor deur en raam - Orthez akna ja ukse montaaživahendid	1		

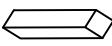
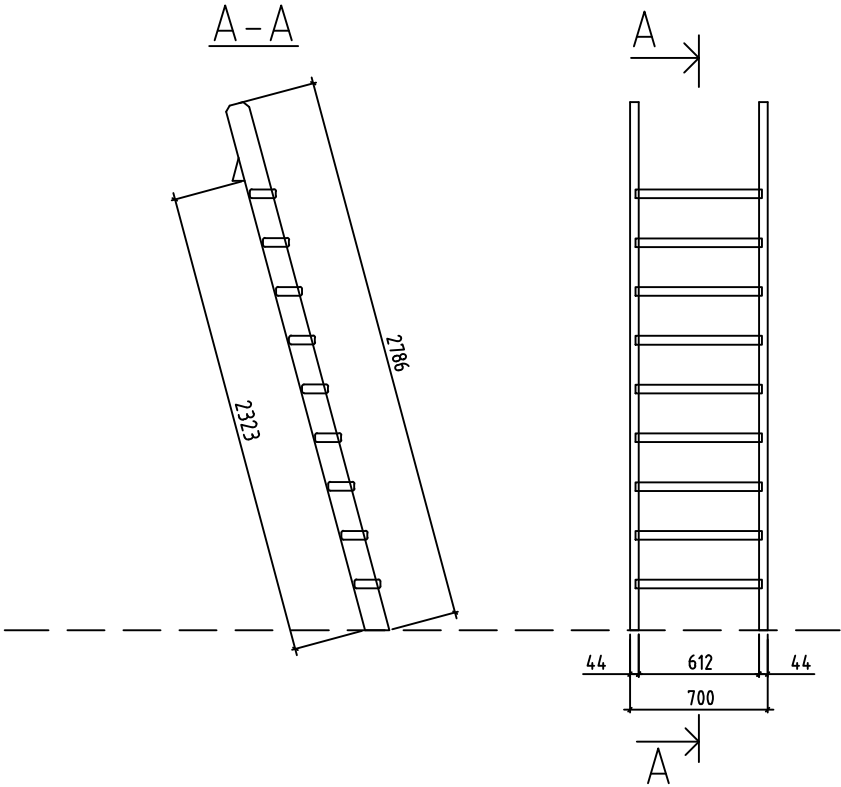
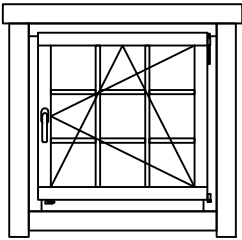
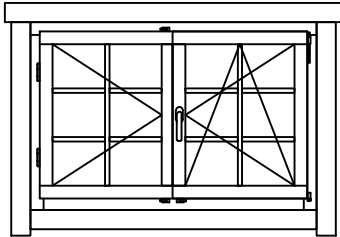
Pos	Valga 7x7, Art.No.7014841 Piece list - Stückliste - Liste des pièces - Elementi - Stuklijst - Tükitabel	Q	P (mm)	L (mm)
GS	Gable segment - Deckblatt - Losange de finition - Decorazione in legno x frontale tetto - Gevelpunt segment - Romb 	2		
SP	Hidden fixing - Holzdübel - Tourillon bois - Fissaggio a scomparsa - Verloren kop spijker - Salapulk 	25		
LR	Ladder - Leiter - Echelle - Scala a pioli - Ladder - Redel  	1		
	Window - Fenster - Fenetre - Finestra - Raam - Aken    916x916 2+ A.9P.K	3		
	Window - Fenster - Fenetre - Finestra - Raam - Aken    1374x916 2+ TA.6P.K	1		

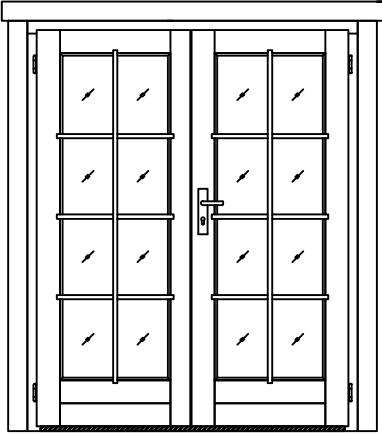
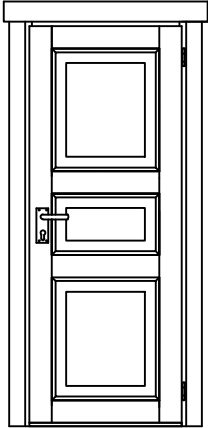
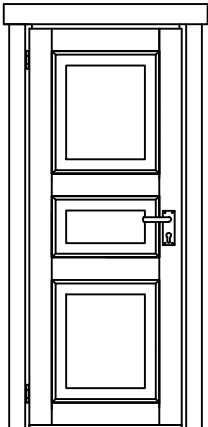
Pos	<p style="text-align: center;">Valga 7x7, Art.No.7014841</p> <p style="text-align: center;">Piece list - Stückliste - Liste des pièces - Elementi - Stuklijst - Tükitabel</p>	Q	P (mm)	L (mm)
	<p>Door - Tür - Porte - Porte - Deur - Uks <span style="float: right;">1580x1933 2+ TU.18P.K</span></p> 	1		
	<p>Door - Tür - Porte - Porte - Deur - Uks +LPL <span style="float: right;">827x1933 U.3TP</span></p> 	1		
	<p>Door - Tür - Porte - Porte - Deur - Uks +LPL <span style="float: right;">827x1933 U.3TV</span></p> 	1		

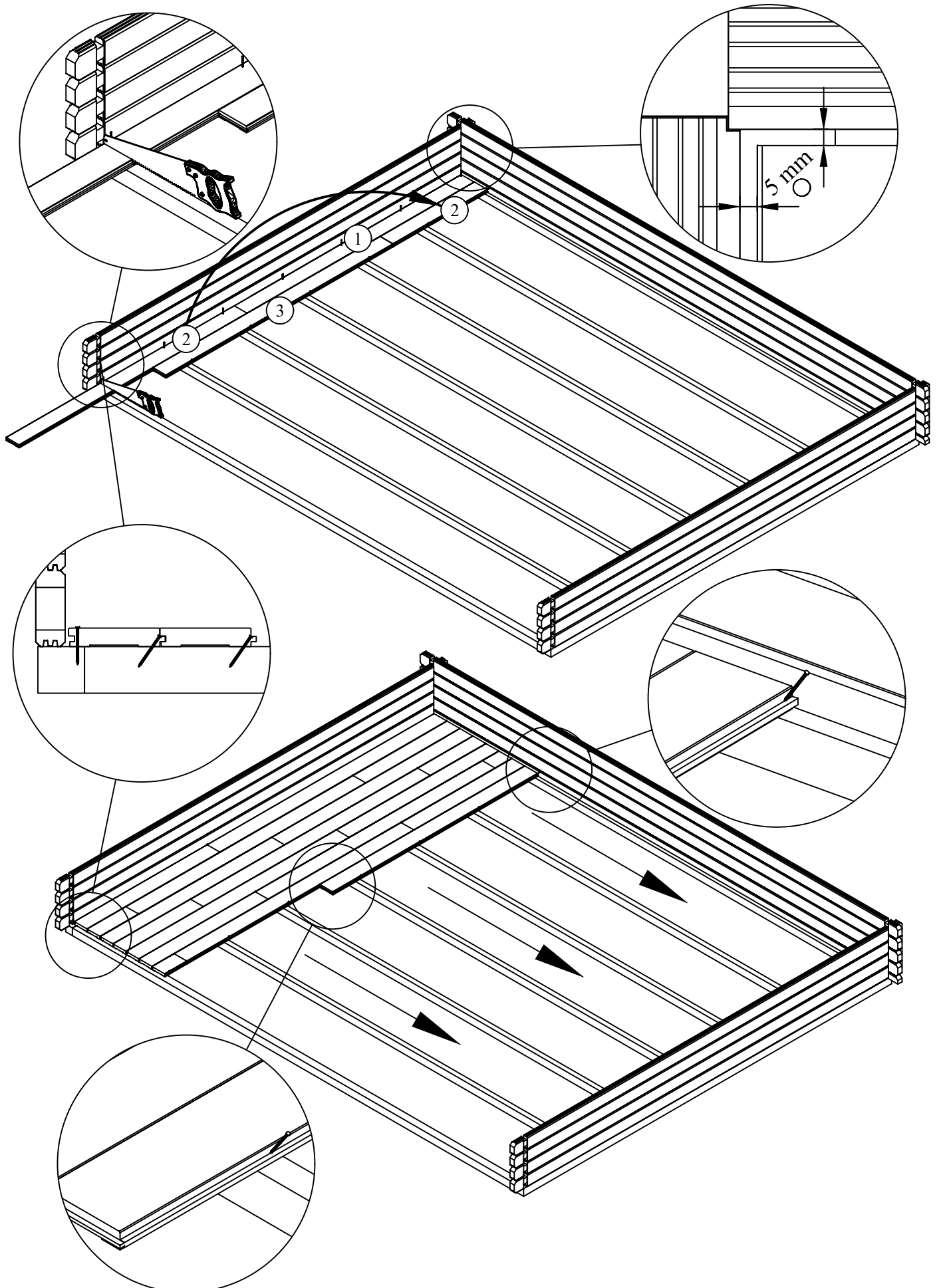

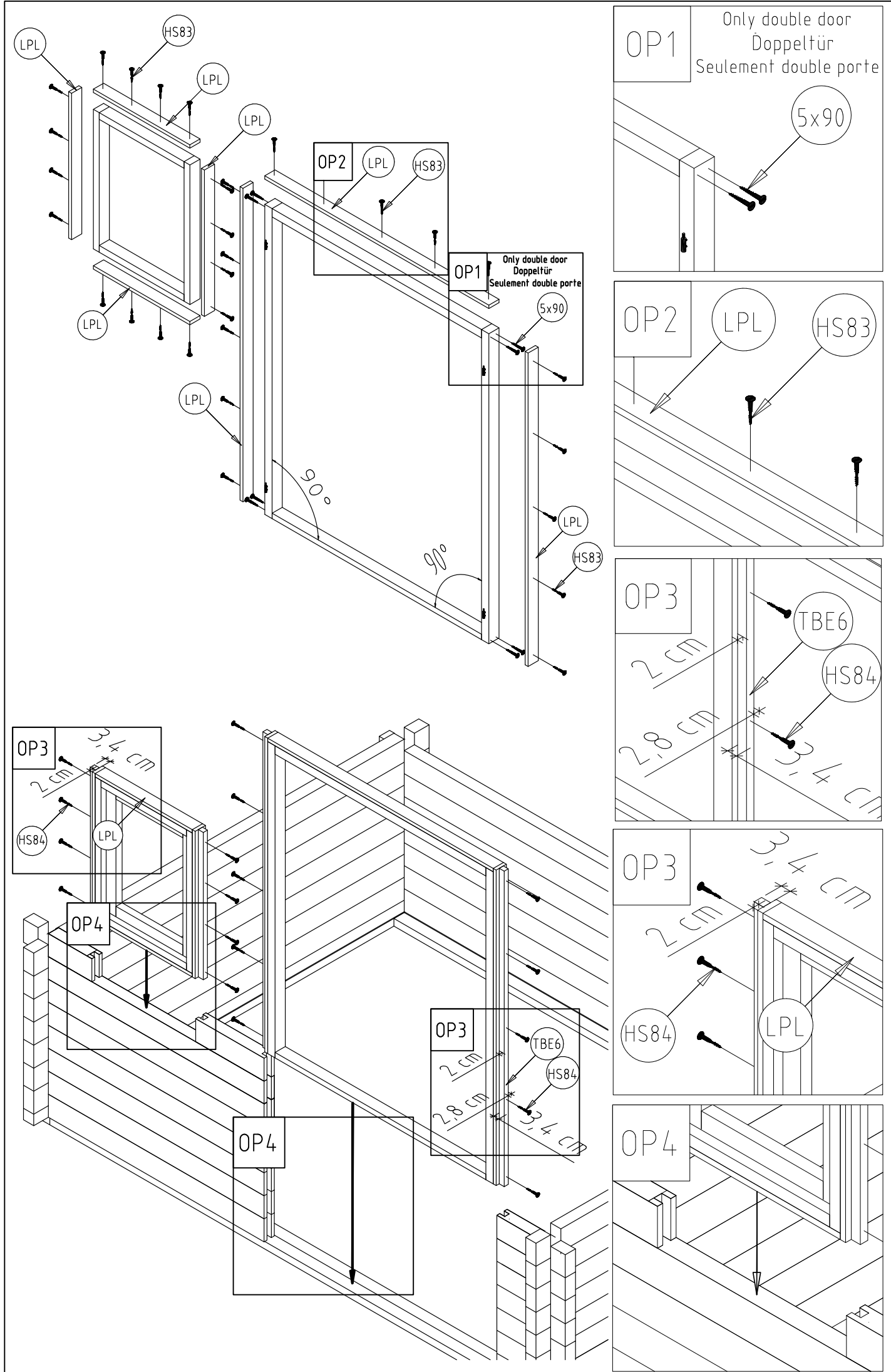

OP1 Only double door  
Doppeltür  
Seulement double porte

