

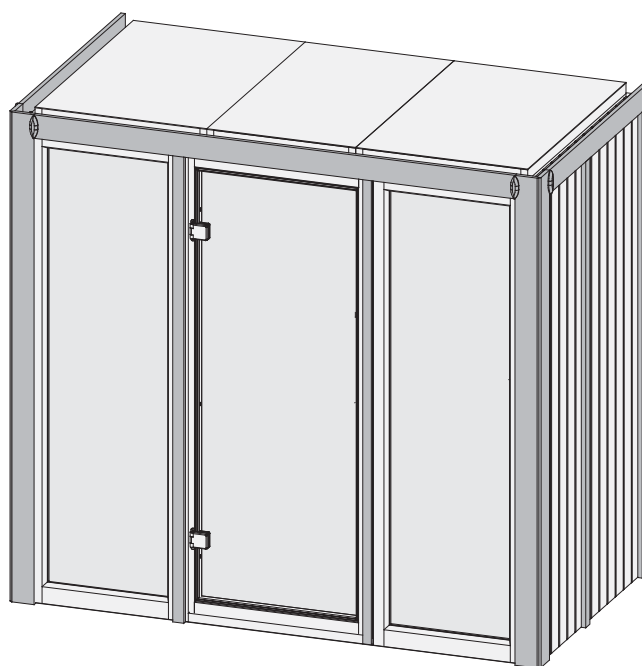

45969



-  **Aufbauanleitung**
-  **Building Instructions**
-  **notice de montage**
-  **montagehandleiding**
-  **Montagevejledning**
-  **Instrucciones de construcción**
-  **Istruzioni per il montaggio**
-  **Montážní návod**



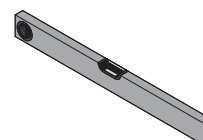
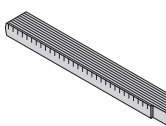
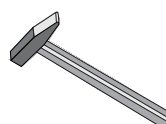
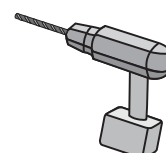
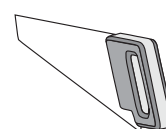



Bitte bewahren Sie die Anleitung und den Garantieschein zur Seriennummer auf.





Vernichten Sie diese erst nach Ablauf der Garantiezeit.





Eventuelle Beanstandungen können mithilfe der Stückliste einfacher zugeordnet werden.





Beigelegte Dokumente

- Informationsheft
- Garantieschein zur Seriennummer
- Typenschild inkl. Warnhinweise (Sauna)
- ggf. Zubehör-Anleitungen in externen Paketen





- *  Nicht im Lieferumfang enthalten
 Not included
 Non comprises dans la livraison
 Niet bijgeleverd

-  No forman parte del suministro
 Non incluso
 V ceně není zahrnuto
 Ikke inkluderet

- 1  Länge muss ermittelt und zugesägt werden
 Length must be determined and sawn
 La longueur doit être déterminée et sciée
 De lengte moet worden bepaald en worden gezaagd

-  La longitud debe ser determinada y aserrada
 La lunghezza deve essere determinata e segata
 Délka musí být určena a rozřezána
 Længden skal bestemmes og savnes





- 2  Nicht gebraucht
 Not needed
 Pas nécessaire
 Niet nodig

-  No es necesario
 Non necessario
 Není nutná
 Ikke nødvendigt





- 3  Mit Zubehör
 With accessories
 Avec accessoires
 Met toebehoren

-  Con accesorios
 Con accessori
 S příslušenstvím
 Med tilbehør

- 4  Fixiert vorübergehend
 Fixed temporarily
 Temporairement fixe
 Tijdelijk vast

-  Temporalmente fijo
 Temporaneamente fisso
 Dočasně pevný
 Midlertidigt rettet

- 5  Bestand vom Haus
 Inventory of the house
 Inventaire de la maison
 Inventaris van het huis

-  Inventario de la casa
 Inventario della casa
 Inventář domu
 Inventar af huset

Werkzeuge / Tools*

X

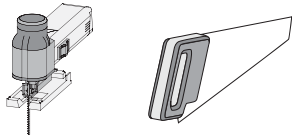

X

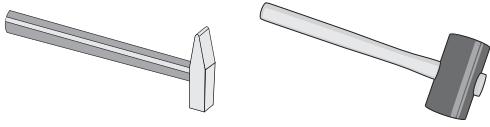

X

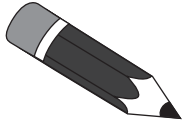

X

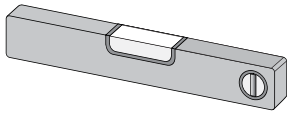

X

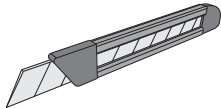

X

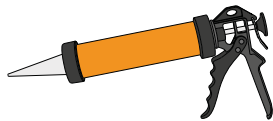
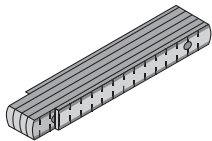

X

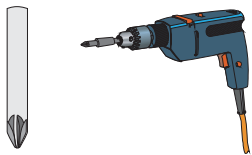

X

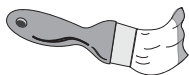
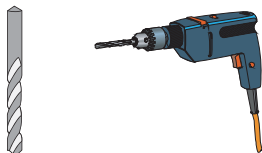

X



Technische Daten

In der Auftragsbestätigung bzw. Lieferschein ist der gekaufte Ofentyp bzw. das erworbene Steuergerät zu finden. Bitte entnehmen Sie die technischen Daten Ihrer Geräte der folgenden Auflistung

Gerät	Netzspannung	Wattage
Öfen		
9kW Ofen Bio	400V ~ 3N	9kW
9kW Ofen (Finnisch)	400V ~ 3N	9kW
9kW Ofen integr. Steuerung	400V ~ 3N	9kW
4,5kW Ofen Bio	400V ~ 3N	4,5kW
4,5kW Ofen (Finnisch)	400V ~ 3N	4,5kW
4,5kW Ofen integr. Steuerung	400V ~ 3N	4,5kW
3,6kW Ofen Bio	230V ~ 1N	3,6kW
3,6kW Ofen (Finnisch)	230V ~ 1N	3,6kW
3,6kW Ofen integr. Steuerung	230V ~ 1N	3,6kW
Steuergeräte		
externe Steuerung Easy Bio	400V ~ 3N	max. 10,8kW
externe Steuerung Plug&Play Bio	240V ~ 3N	max. 10,8kW
externe Steuerung (Finnisch)	400V ~ 3N	max. 10,8kW
externe Steuerung Plug&Play (Finnisch)	240V ~ 3N	max. 10,8kW
Multisteuergerät	400V ~ 3N	max. 10,5kW
externe Steuerung Classic Bio	400V ~ 3N	max. 9kW
externe Steuerung Classic (Finnisch)	400V ~ 3N	max. 9kW
externe Steuerung Premium Bio	400V ~ 3N	max. 12kW
externe Steuerung Premium (Finnisch)	400V ~ 3N	max. 9kW



Vergleichen Sie zuerst die Material-liste mit Ihrem Paketinhalt! Bitte haben Sie Verständnis, dass Beanstandungen nur im nicht aufgebauten Zustand bearbeitet werden können!



Vergelijk eerst de lijst van materialen met de inhoud van uw pakket! Reclamaties kunnen alleen in behandeling worden genomen zolang de onderdelen nog niet zijn gemonteerd!



Confrontate questa distinta materiali prima con il contenuto del pacchetto! Vi preghiamo di comprendere che eventuali reclami possono essere accolti solo prima del montaggio!



First compare the list of materials with your package contents! Please understand that complaints can be processed in the non-built status only!



Start med at kontrollere materialelisten med indholdet af den leverede pakke! Vi gør venligst opmærksom på at reklamationer kun kan behandles for materialer som ikke er blevet bearbejdet!



Nejprve přezkontrolujte obsah balení podle materiálového listu! Mějte pochopení pro to, že případnou reklamaci se můžeme zabývat pouze tehdy, když díly nebudou smontované! Za pomoci tohoto seznamu můžete jednotlivé díly přiřadit k montážnímu návodu.



Commencez par comparer la liste du matériel avec le contenu de votre paquet! Sachez que nous traitons uniquement les réclamations concernant le matériel à l'état non monté!



En primer lugar, compare la lista de material con el contenido del paquete. Rogamos entienda que las reclamaciones sólo pueden ser tramitadas antes de montar el objeto!

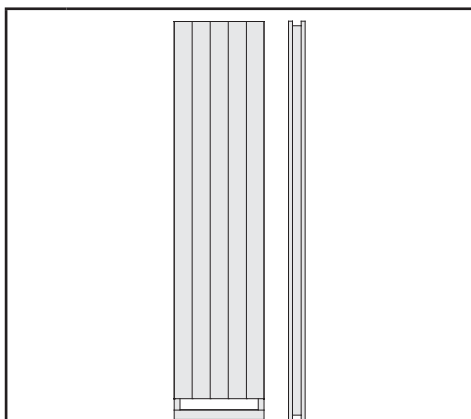
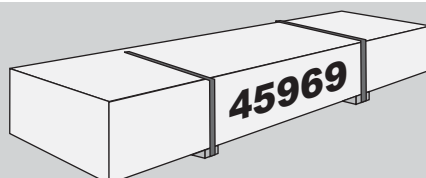

1 x **W1** | 1920 x 433 x 68 mm | ID 52645

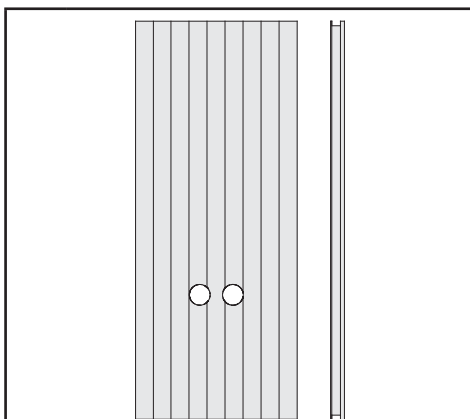

1 x **W2** | 1920 x 780 x 57 mm | ID 70556

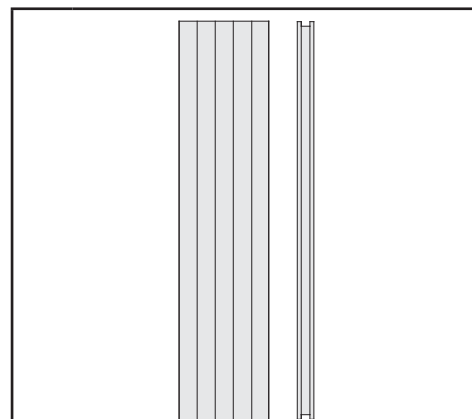

1 x **W3** | 1920 x 433 x 68 mm | ID 25547

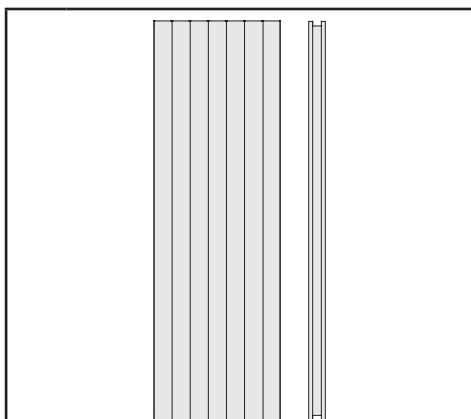

2 x **W4** | 1920 x 606 x 68 mm | ID 25548

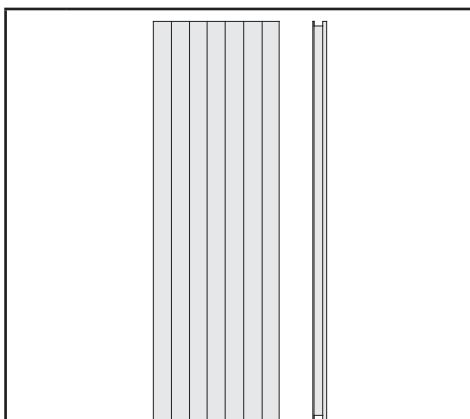

2 x **W5** | 1920 x 606 x 57 mm | ID 23624

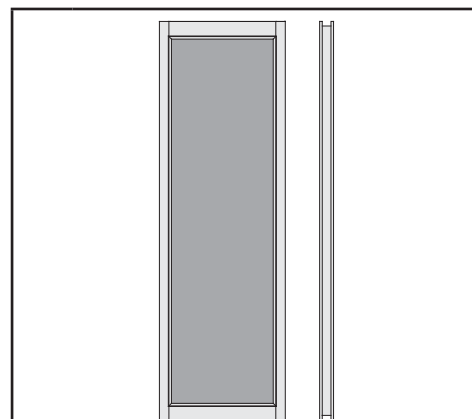

2 x **W6** | 1920 x 606 x 68 mm | ID 47717

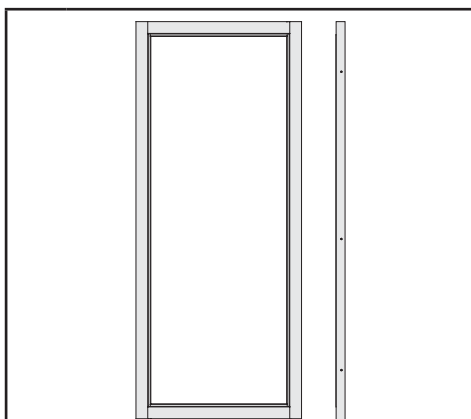

1 x **X1** | 1872 x 780 x 68 mm | ID 26499

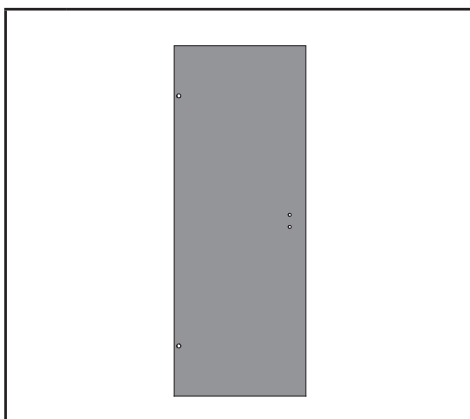

1 x **X2** | | ID 26494

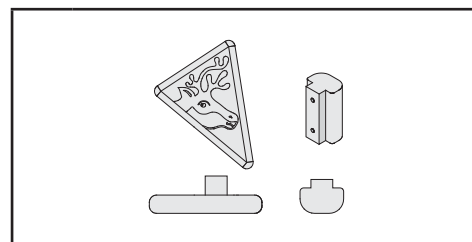

1 x **X3** | | ID 26114

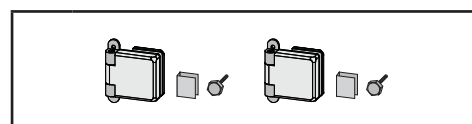

1 x **X4** | | ID 26496

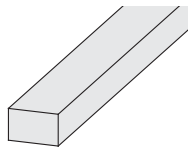

6 x B1	1920 x 19 x 3 mm	ID 20799
4 x B2	750 x 36 x 12 mm	ID 24239
4 x B3	1920 x 36 x 12 mm	ID 24846
1 x B4	1985 x 90 x 16 mm	ID 36745
6 x B5	1884 x 45 x 17 mm	ID 48037
2 x B6	70 x 45 x 18 mm	ID 26366
9 x B7	460 x 95 x 18 mm	ID 25412
2 x B8	1104 x 95 x 18 mm	ID 79670
1 x B9	1958 x 95 x 18 mm	ID 72397
1 x B10	300 x 120 x 18 mm	ID 22467
2 x B11	158 x 42 x 28 mm	ID 43747
2 x B12	550 x 42 x 28 mm	ID 83494
2 x B13	770 x 42 x 28 mm	ID 45968
2 x B14	1035 x 42 x 28 mm	ID 25743
2 x B15	1080 x 42 x 28 mm	ID 45157
4 x B16	1145 x 42 x 28 mm	ID 25754
2 x B17	1935 x 42 x 28 mm	ID 57824
4 x B18	2018 x 42 x 28 mm	ID 52821
2 x B19	1874 x 52 x 52 mm	ID 26165

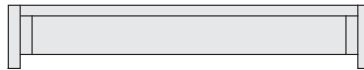
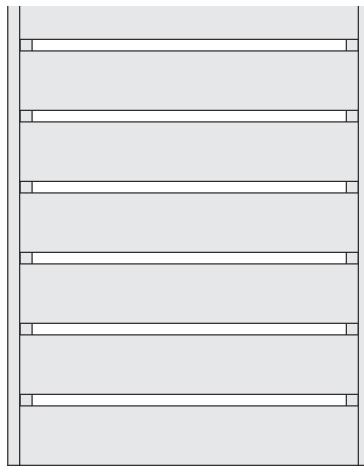

1 x L1	442 x 410 x 90 mm	ID 26745
1 x L2	1985 x 550 x 90 mm	ID 36746

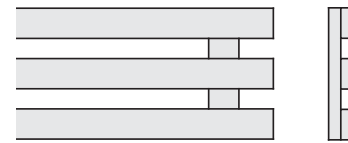

2 x L3	1983 x 174 x 32 mm	ID 38153
---------------	--------------------	----------

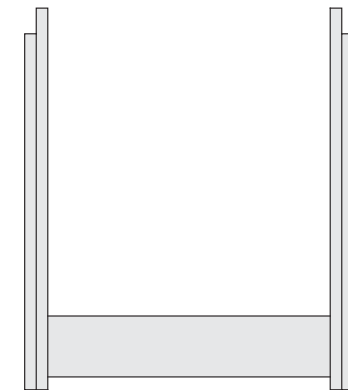

2 x H1	410 x 400 x 95 mm	ID 59941
---------------	-------------------	----------

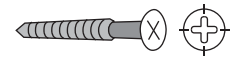

49 x	4 x 30 mm	ID 3686
15 x	4 x 40 mm	ID 21925
45 x	4 x 50 mm	ID 3688
32 x	4 x 70 mm	ID 3689
40 x	4,5 x 80 mm	ID 9204
10 x	6 x 60 mm	ID 14014

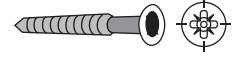

74 x	4,5 x 40 mm	ID 26285
------	-------------	----------

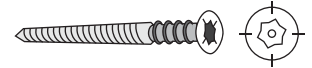

6 x	6 x 80 mm	ID 14266
-----	-----------	----------



6 x		ID 46403
74 x		ID 26116

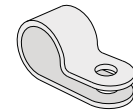

1 x		ID 50420
-----	--	----------

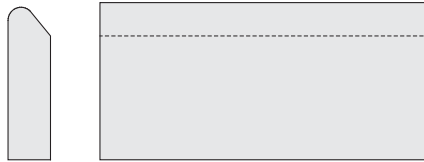

4 x G1	1980 x 95 x 17 mm	ID 48540
---------------	-------------------	----------

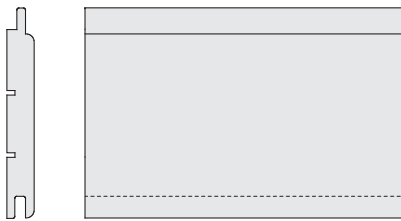

2 x R1	1920 x 97 x 12 mm	ID 22863
---------------	-------------------	----------

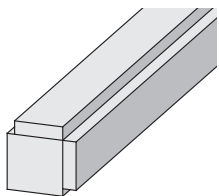

2 x K1	1874 x 64 x 64 mm	ID 24725
---------------	-------------------	----------

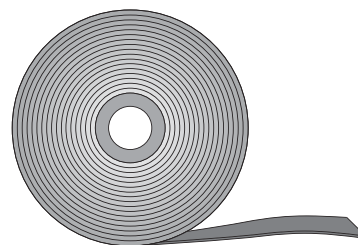

1 x	10 m	ID 14025
-----	------	----------

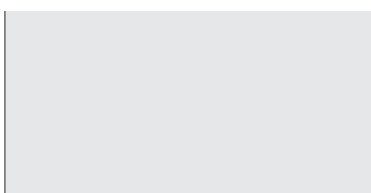

1 x M1	1058 x 606 x 57 mm	ID 45979
2 x M2	1058 x 700 x 57 mm	ID 45655

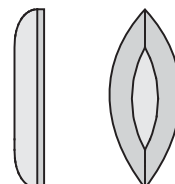

4 x		ID 26272
-----	--	----------

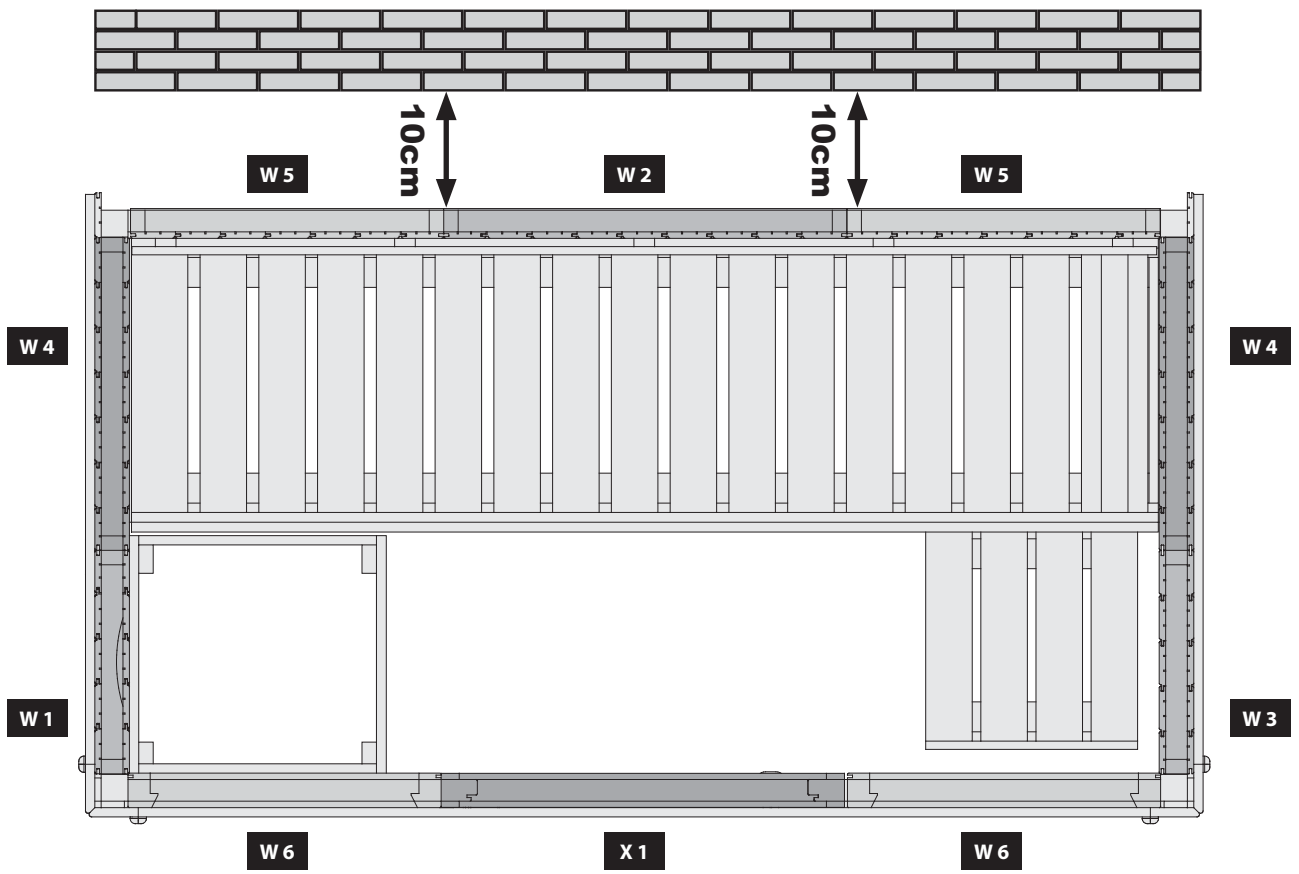

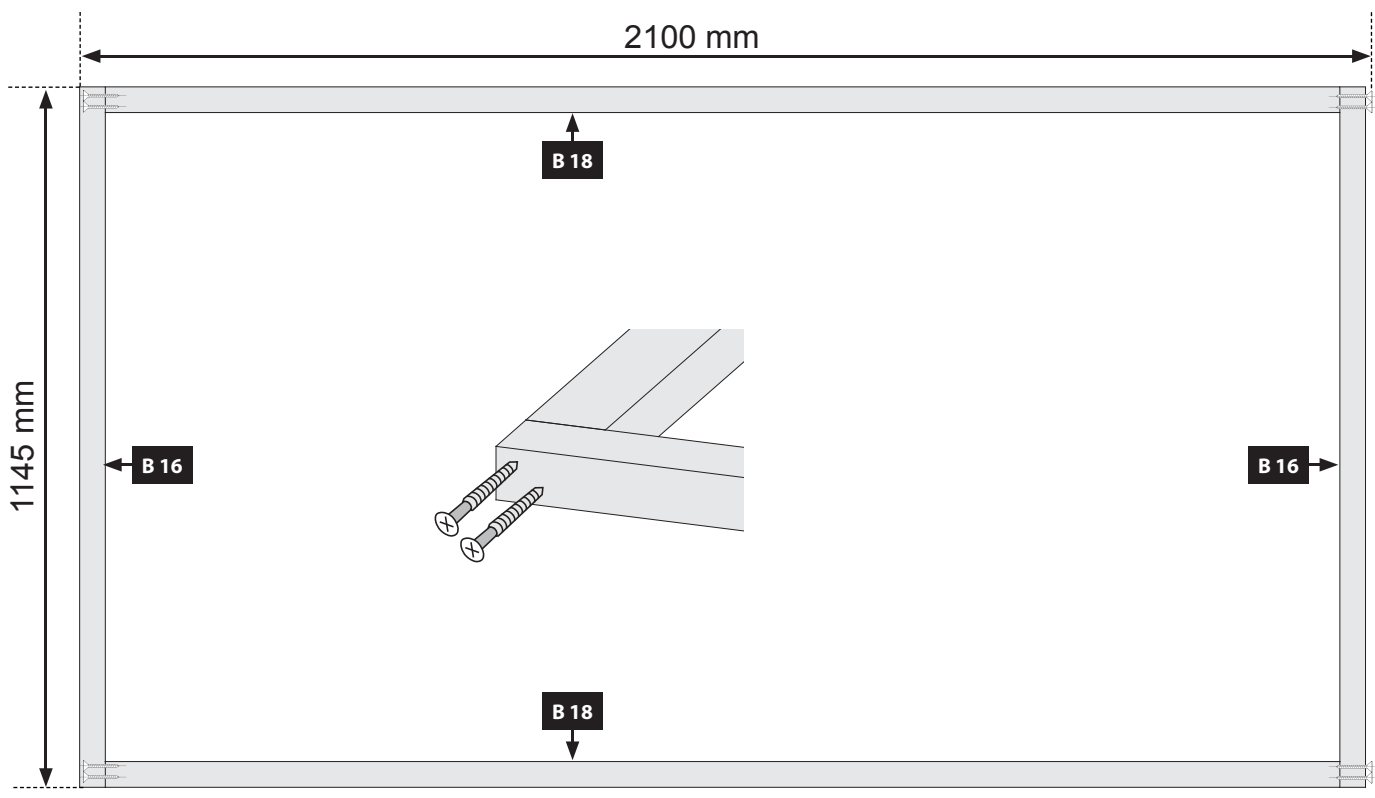
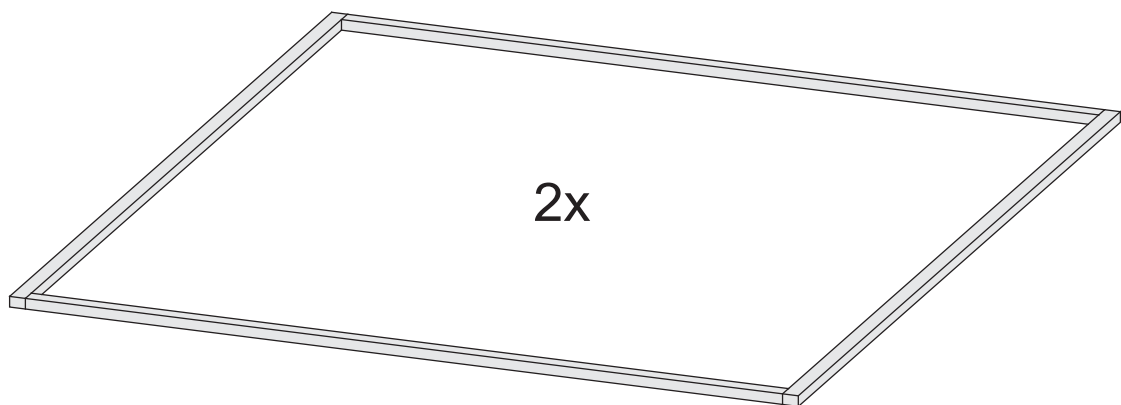
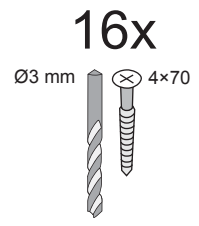
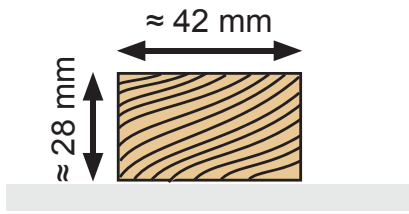

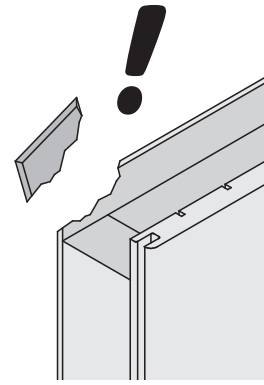
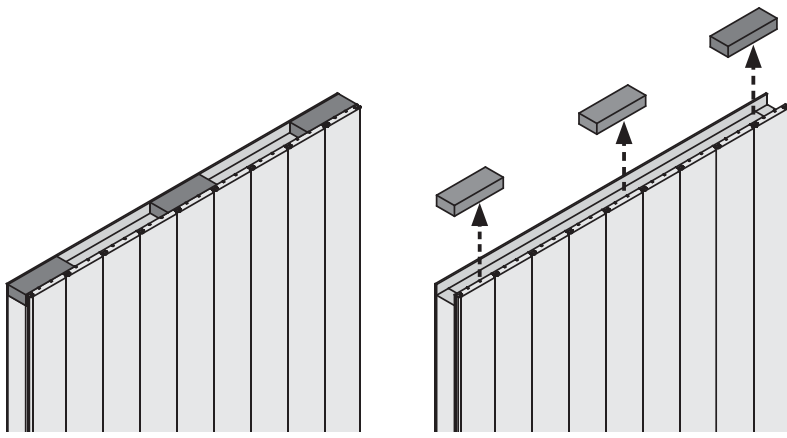

-  Vorsicht!
-  Attention!
-  Attention!
-  Voorzichtig!
-  Forsigtig!
-  Cuidado!
-  Occhio!
-  Pozor!

02

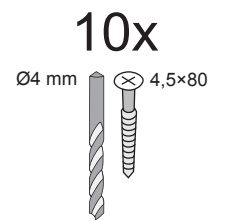
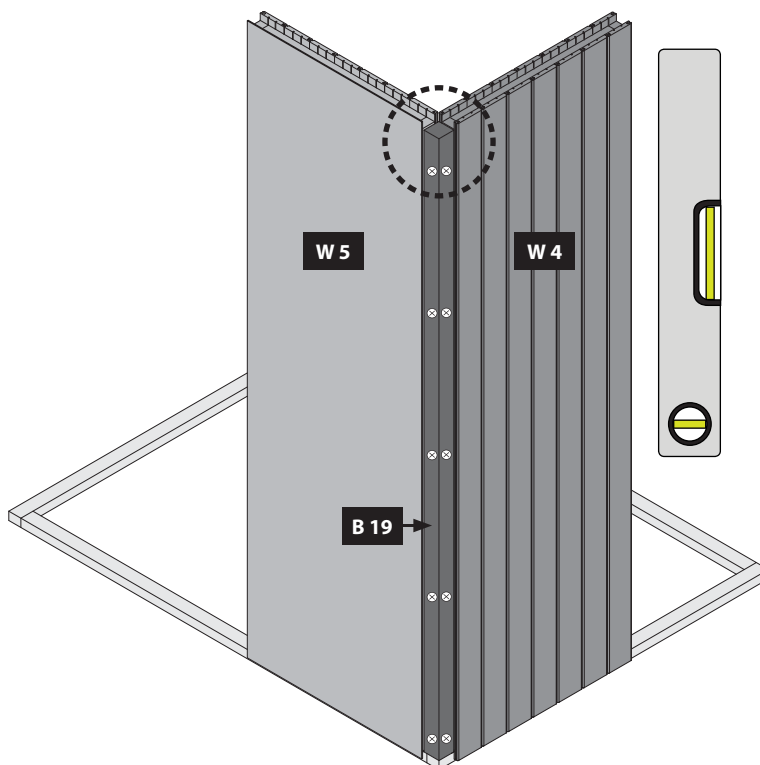
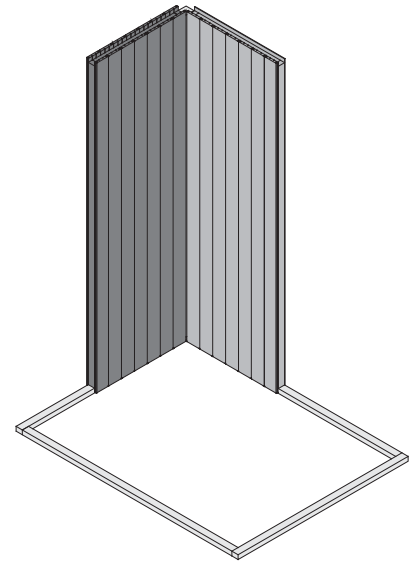
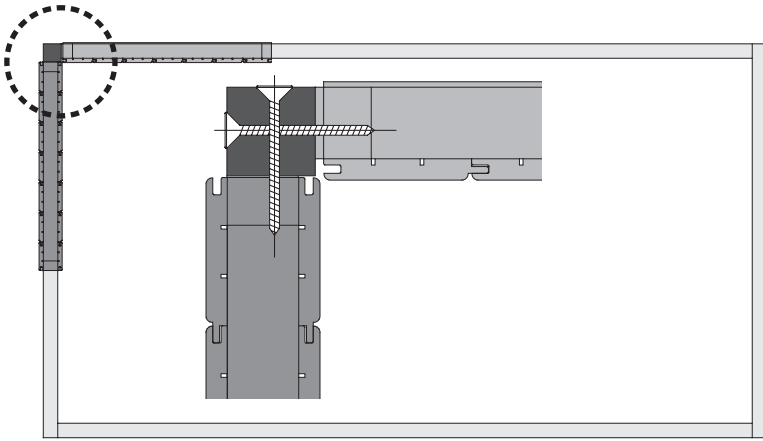

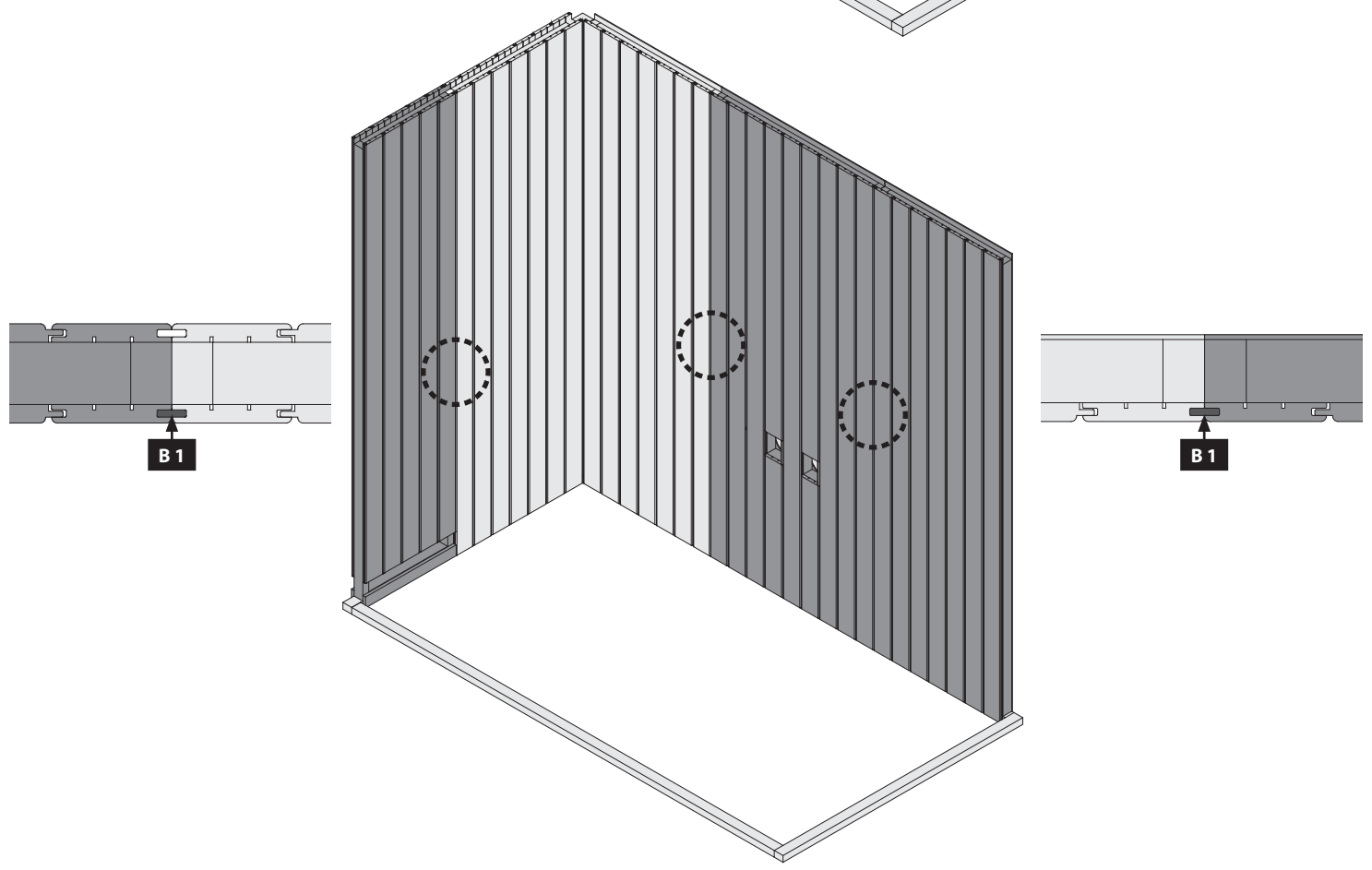
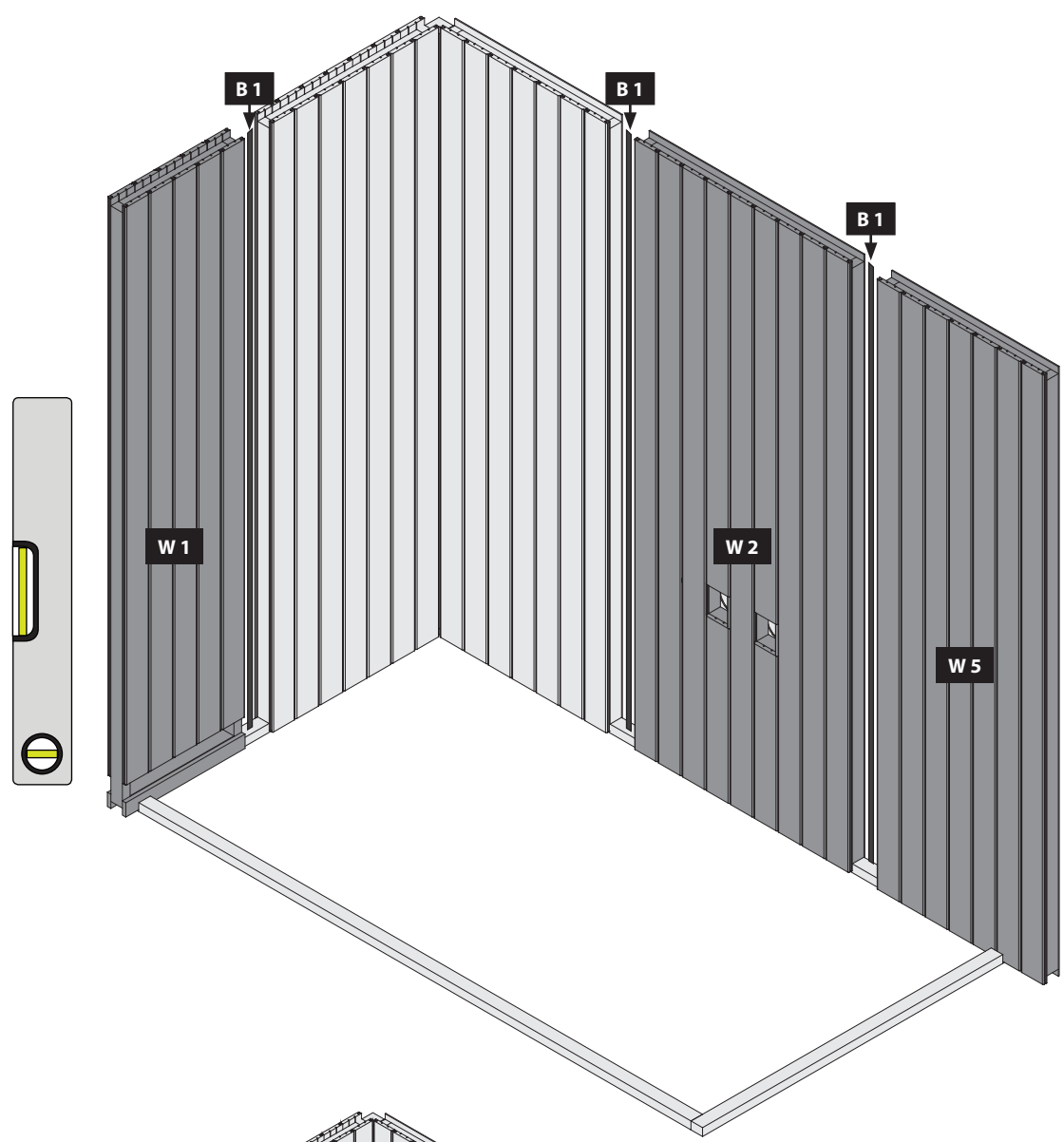

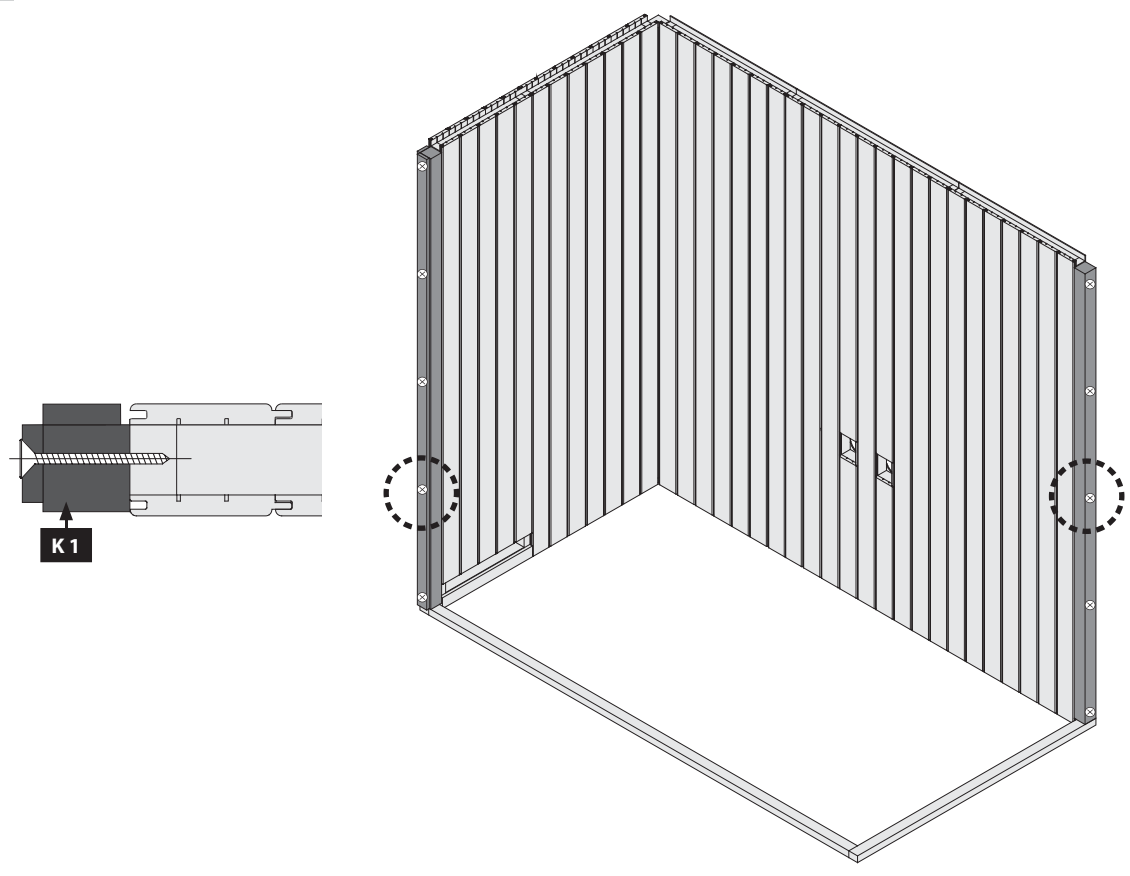

10x

Ø3 mm 4,5x80

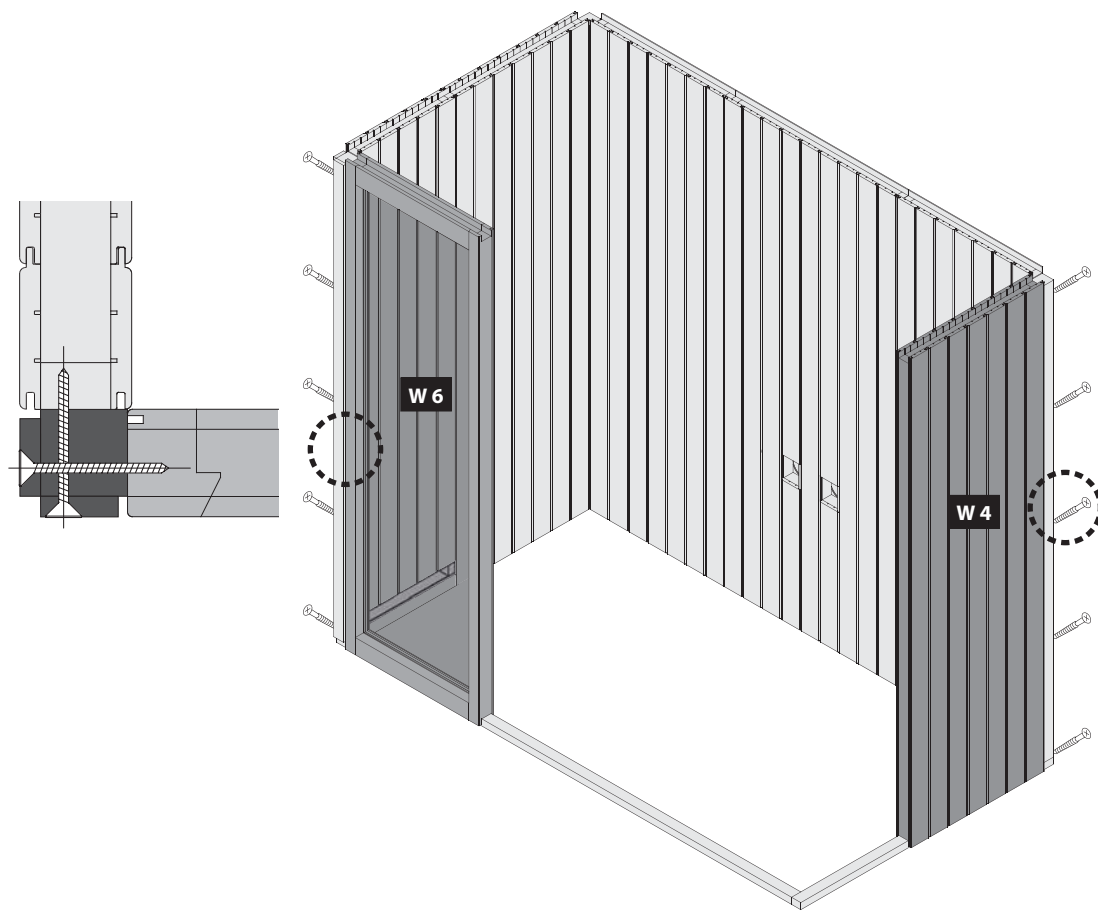
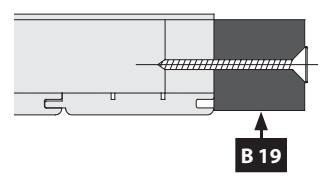
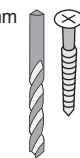

10x

Ø3 mm 4,5x80

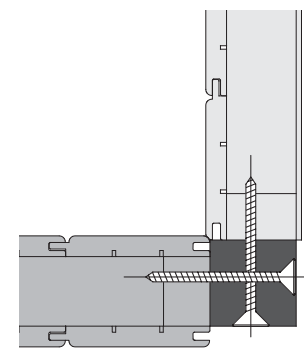
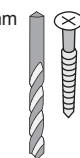

5x

Ø3 mm 4,5x80

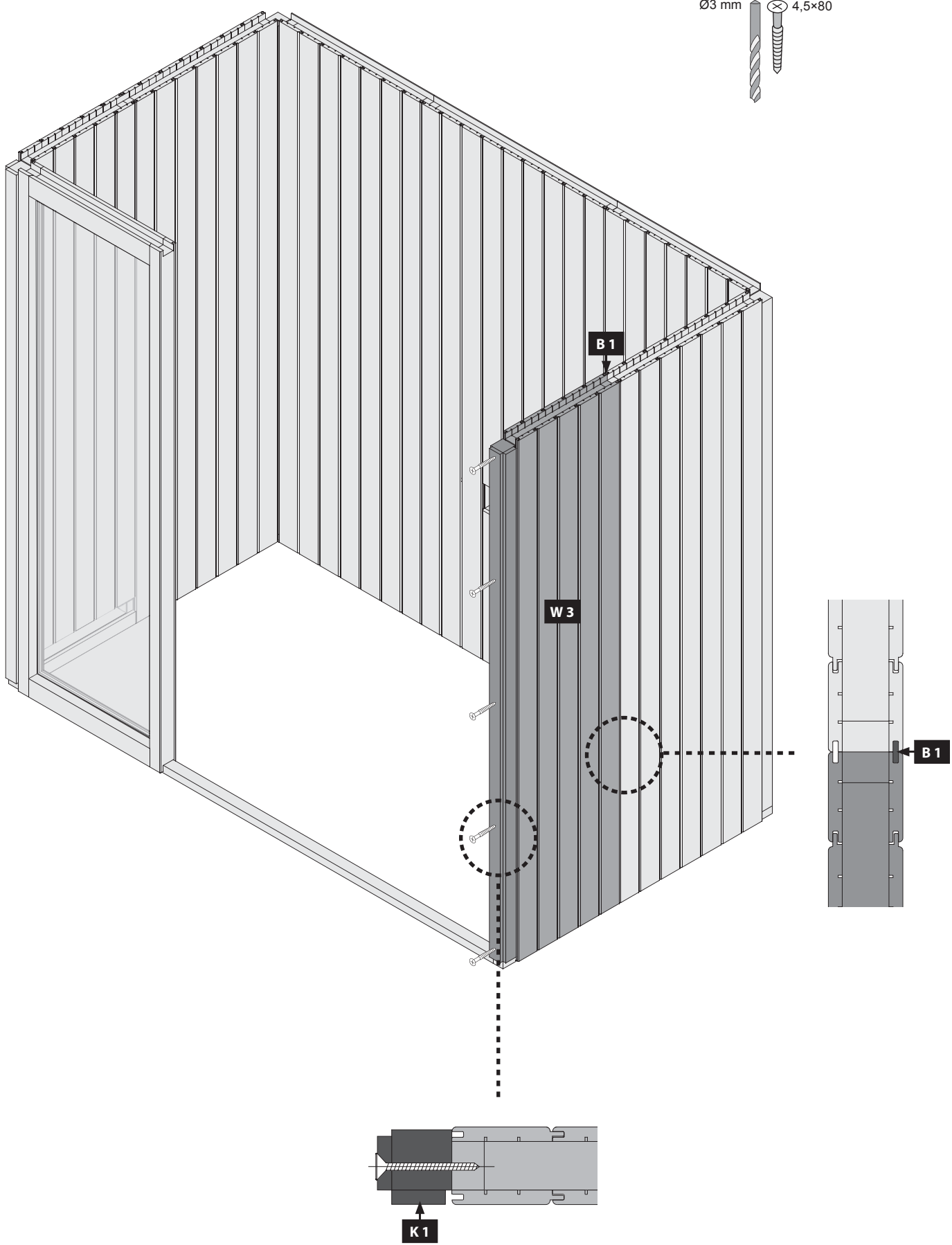
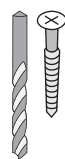

B 1

W 3





B 1



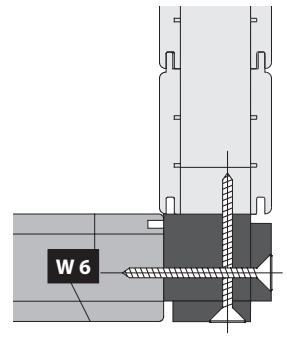
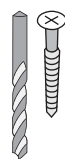

K 1

5x

Ø3 mm 4,5x80



-  Einbau Glastür
-  Installation of glass door
-  Montage porte en verre
-  Montage van de glazen deur

-  Installationsglasdør
-  Montaje de la puerta de cristal
-  Installazione portello di vetro
-  Sauna Instalace dveře

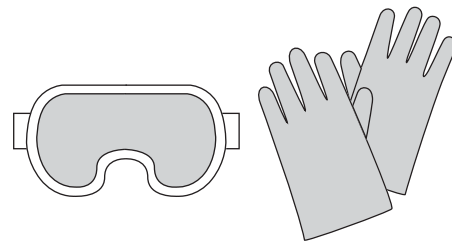

08



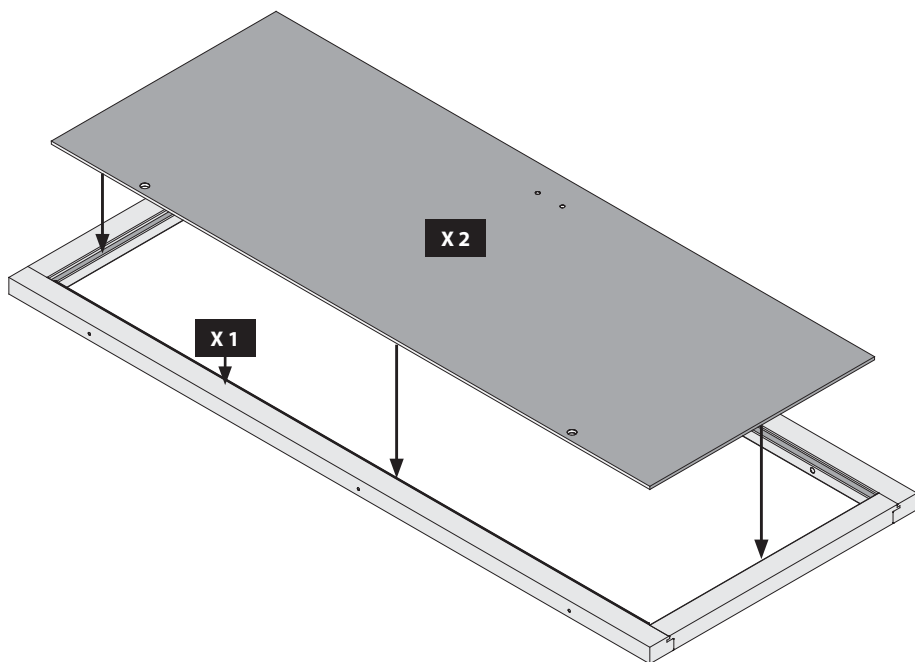

-  Saunätürglas in den Türrahmen legen
-  Put the door glass in the frame
-  Mettez le verre de la porte dans le cadre
-  Plaats het deurglas in het frame
-  Sæt dørglasset i rammen
-  Pon el vidrio de la puerta en el marco
-  Metti il vetro della porta nel telaio
-  Vložte sklo dveří do rámu



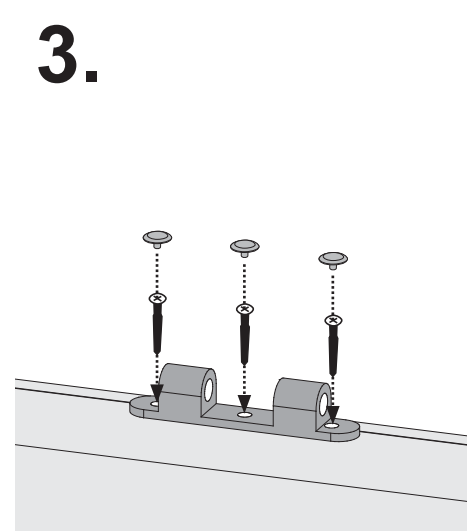
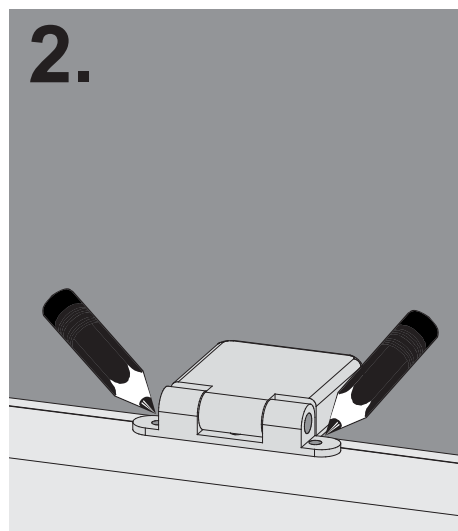
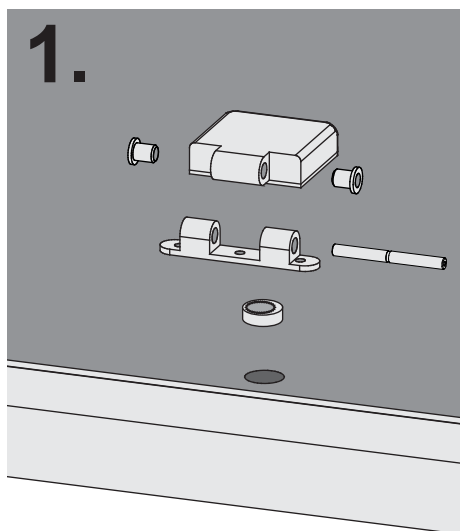
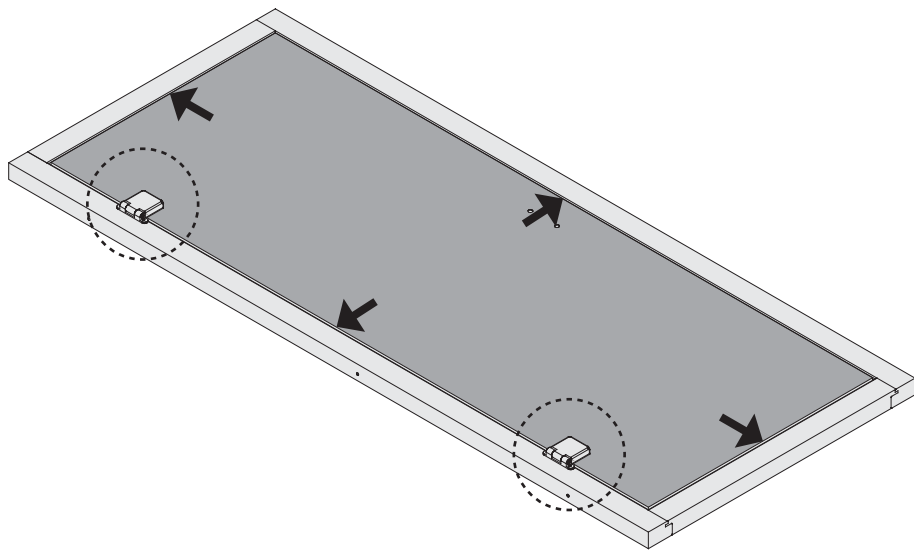



09

-  Saunätürglas in den Türrahmen ausrichten
-  Center the glass in the wooden frame
-  Bien aligner le verre à vitre
-  Lijn het glas uit in het deurframe
-  Juster saunaens dørglas i dørkarmen
-  Alinee el vidrio en el marco de la puerta
-  Allineare il vetro nel telaio della porta
-  Skleněná dvířka sauna v zárubně zarovnat





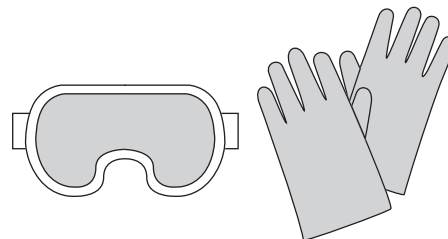

 Einbau Glastür
 Installation of glass door
 Montage porte en verre
 Montage van de glazen deur



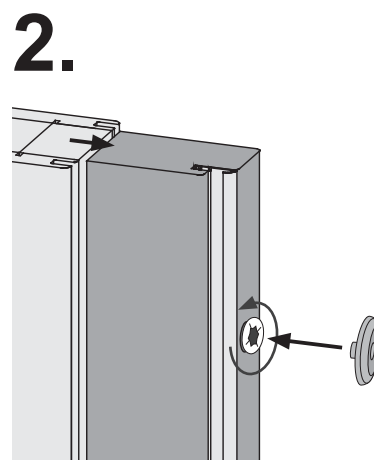
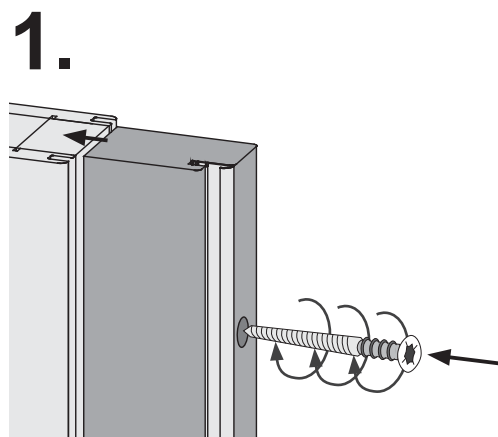
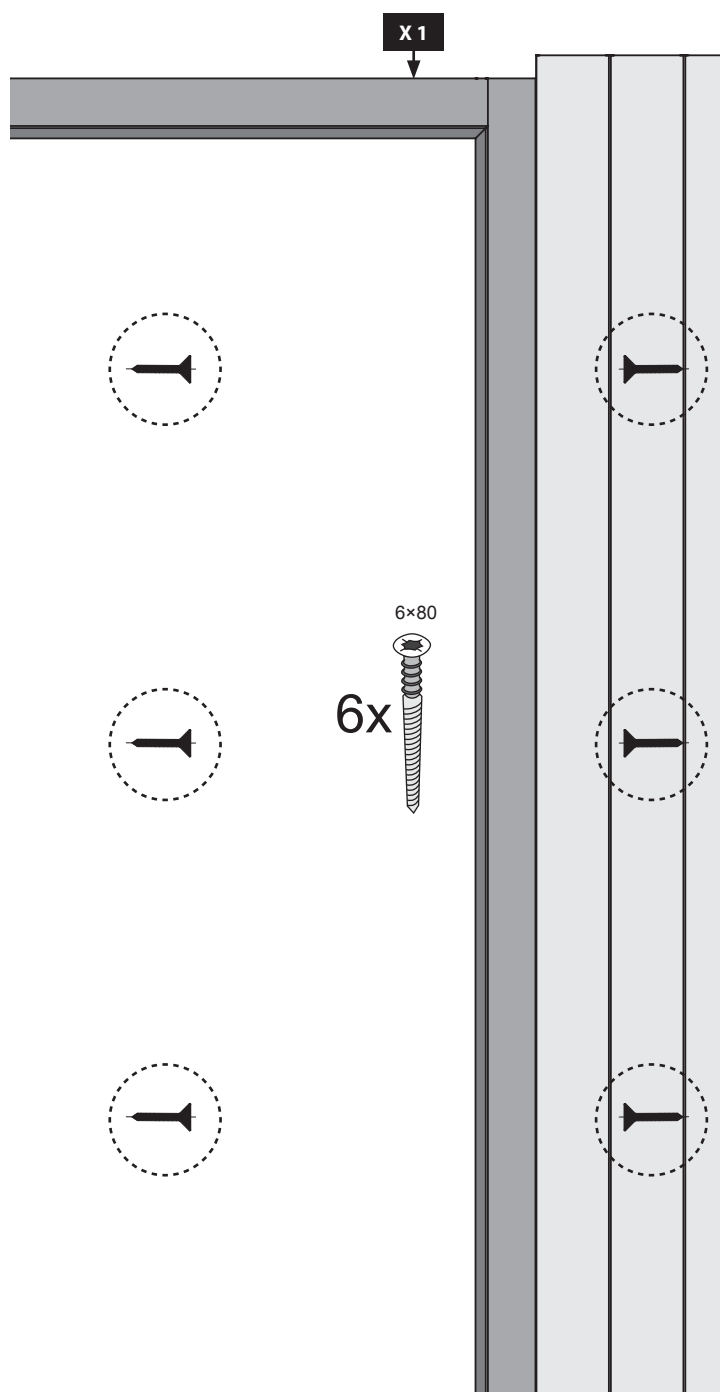
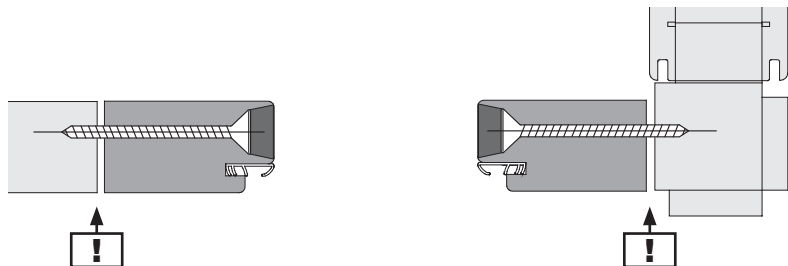

 Installationsglasdør
 Montaje de la puerta de cristal
 Installazione portello di vetro
 Sauna Instalace dveře



10



-  Einbau Glastür
-  Installation of glass door
-  Montage porte en verre
-  Montage van de glazen deur

-  Installationsglasdør
-  Montaje de la puerta de cristal
-  Installazione portello di vetro
-  Sauna Instalace dveře

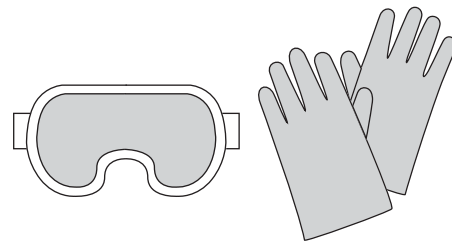

11

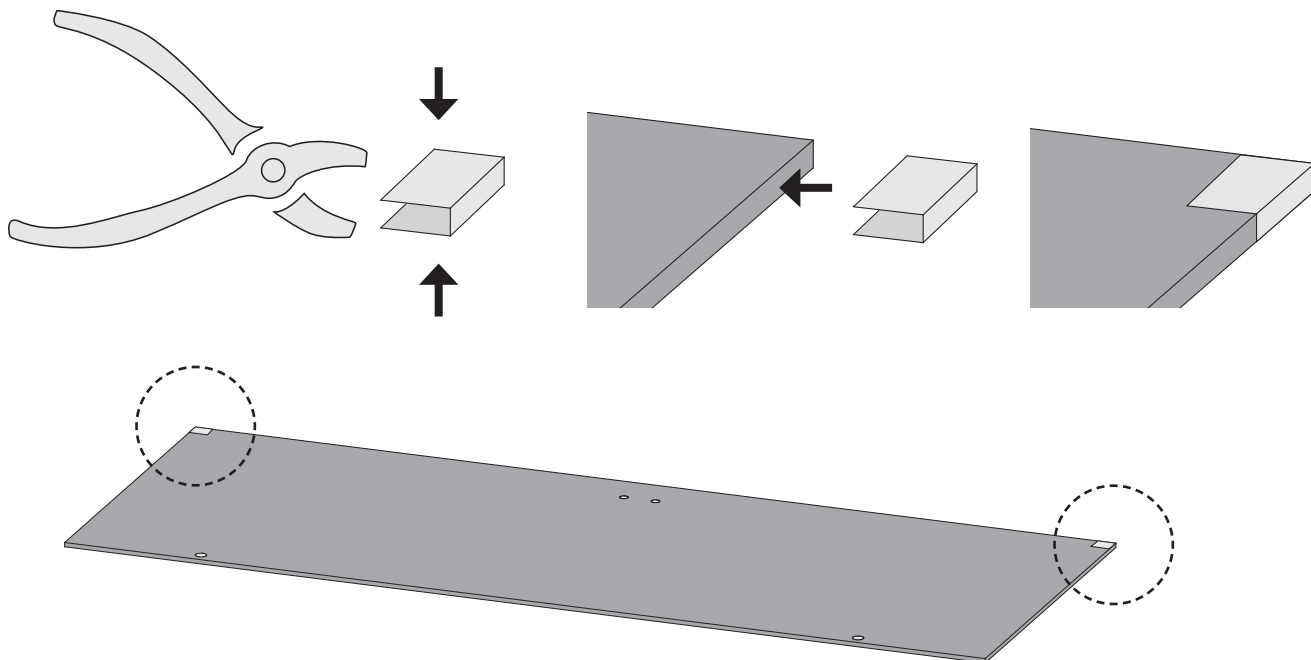



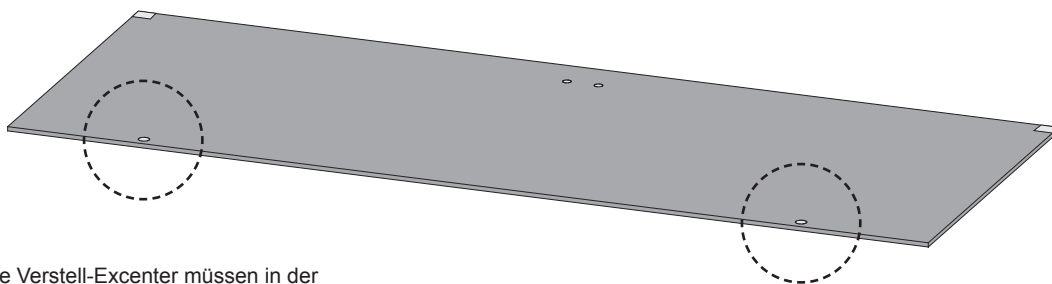



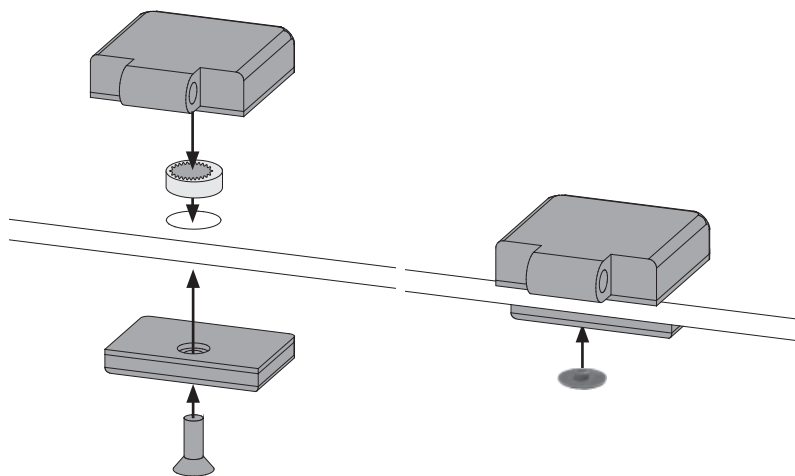

12



-  Alle Verstell-Excenter müssen in der Glasscheibe die gleiche Grundstellung haben
-  All adjustable eccentrics must have the same basic adjustment in the glass panel
-  Tous les excentreurs de positionnement doivent avoir la même position de base dans la vitre
-  Alle excentrische verstelelementen moeten in dezelfde stand in de glasplaat worden geplaatst
-  Alle justeringsexcenter skal have samme grundlæggende position i glasruden
-  Todos los excéntricos regulables tienen que tener la misma posición base en la hoja de cristal
-  Tutti gli eccentrici di regolazione devono avere la stessa posizione base nella lastra di vetro
-  šechny nastavovací podivínů musí mít stejný základní polohy ve skle





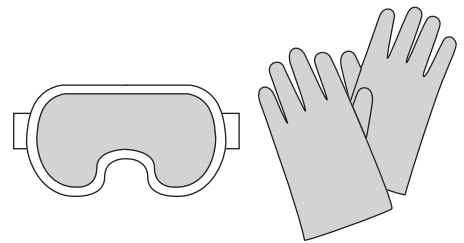

-  Einbau Glastür
-  Installation of glass door
-  Montage porte en verre
-  Montage van de glazen deur



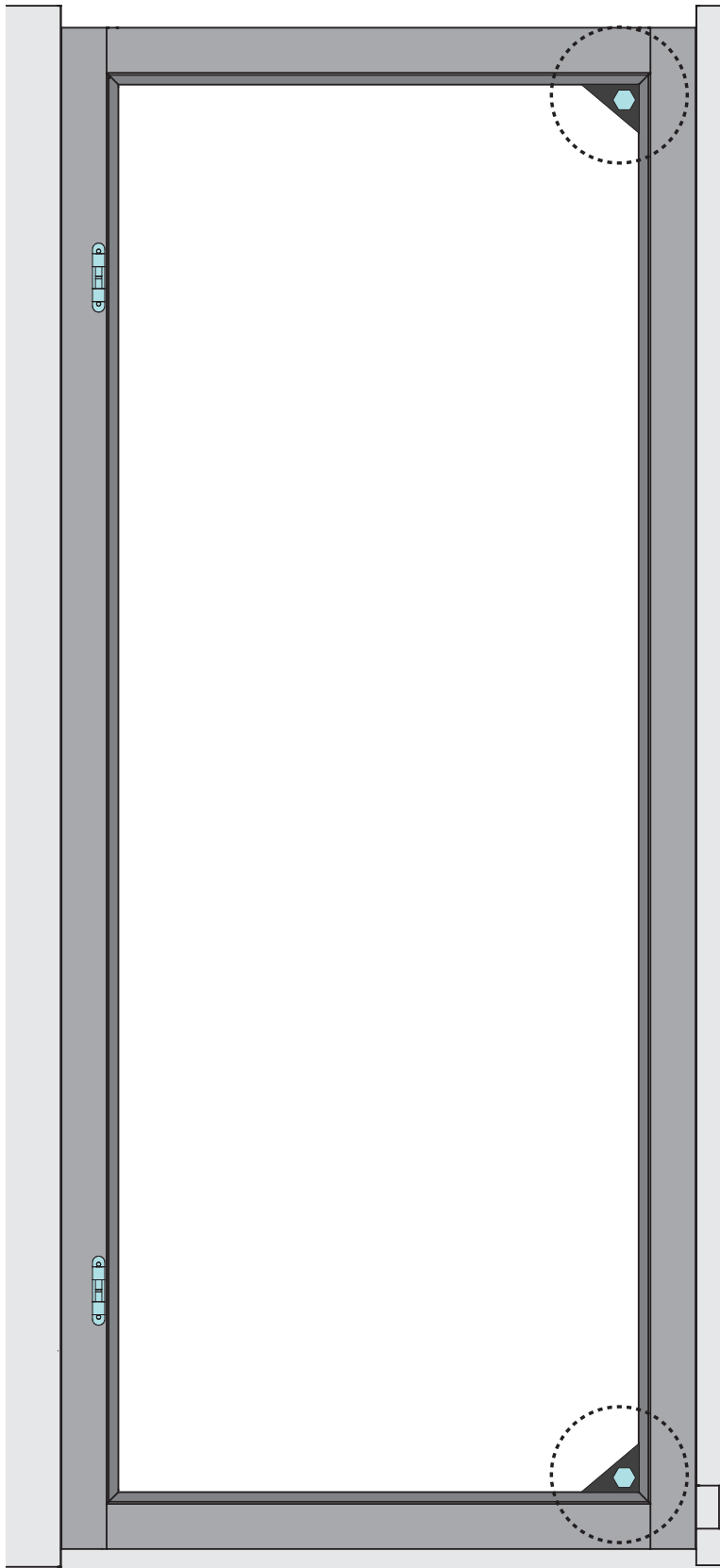

-  Installationsglasdør
-  Montaje de la puerta de cristal
-  Installazione portello di vetro
-  Sauna Instalace dveře



13







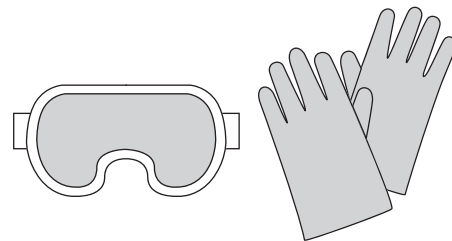



-  Einbau Glastür
-  Installation of glass door
-  Montage porte en verre
-  Montage van de glazen deur

-  Installationsglasdør
-  Montaje de la puerta de cristal
-  Installazione portello di vetro
-  Sauna Instalace dveře



14

-  Alle Verstell-Excenter müssen in der Glasscheibe die gleiche Grundstellung haben
-  All adjustable eccentrics must have the same basic adjustment in the glass panel
-  Tous les excentreurs de positionnement doivent avoir la même position de base dans la vitre
-  Alle excentrische verstelelementen moeten in dezelfde stand in de glasplaat worden geplaatst

-  Alle justeringsexcentricer skal have samme grundlæggende position i glasruden
-  Todos los excéntricos regulables tienen que tener la misma posición base en la hoja de cristal
-  Tutti gli eccentrici di regolazione devono avere la stessa posizione base nella lastra di vetro
-  všechny nastavovací podivínů musí mít stejný základní polohy ve skle

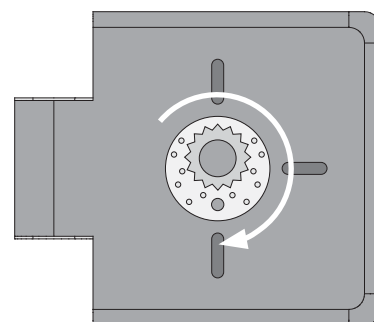
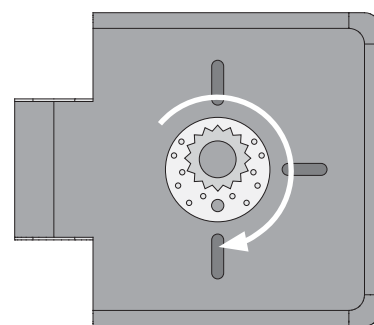
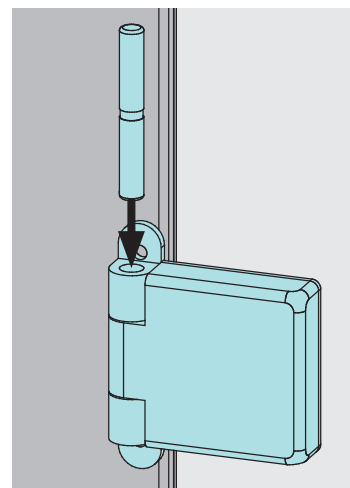
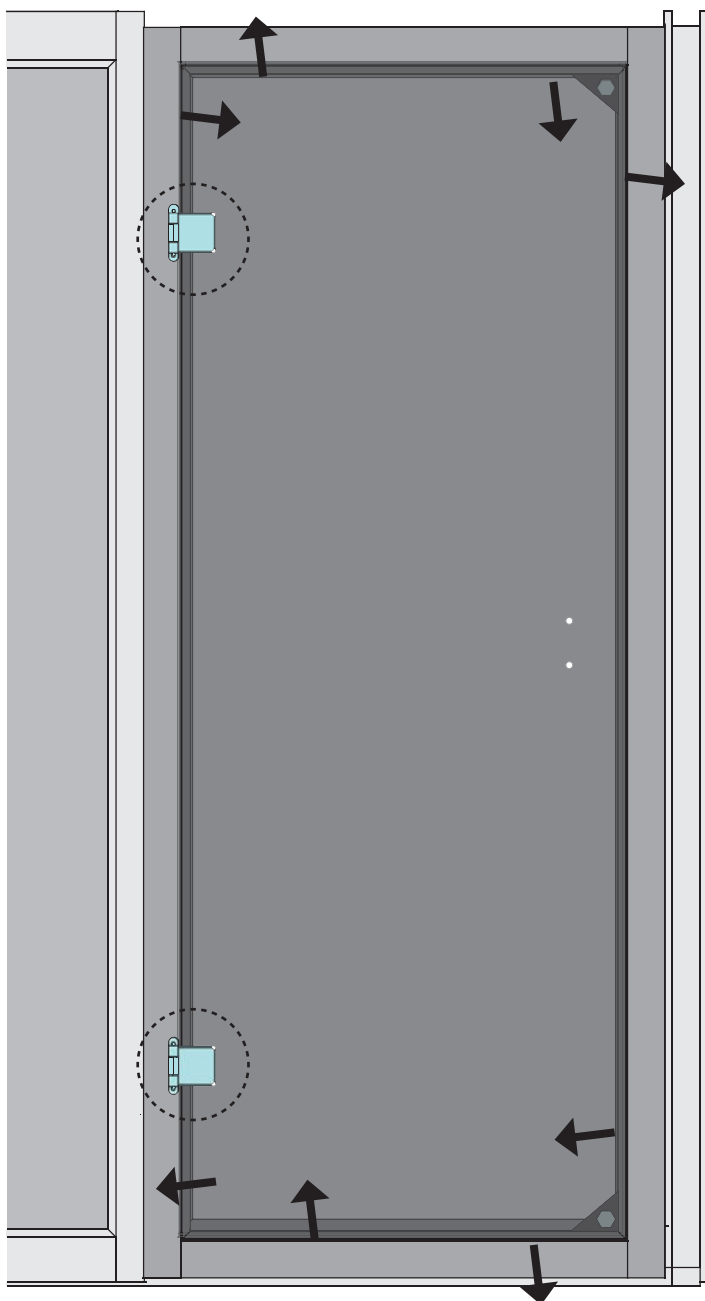

1.

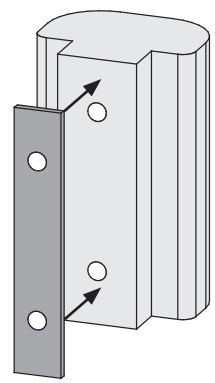

2.

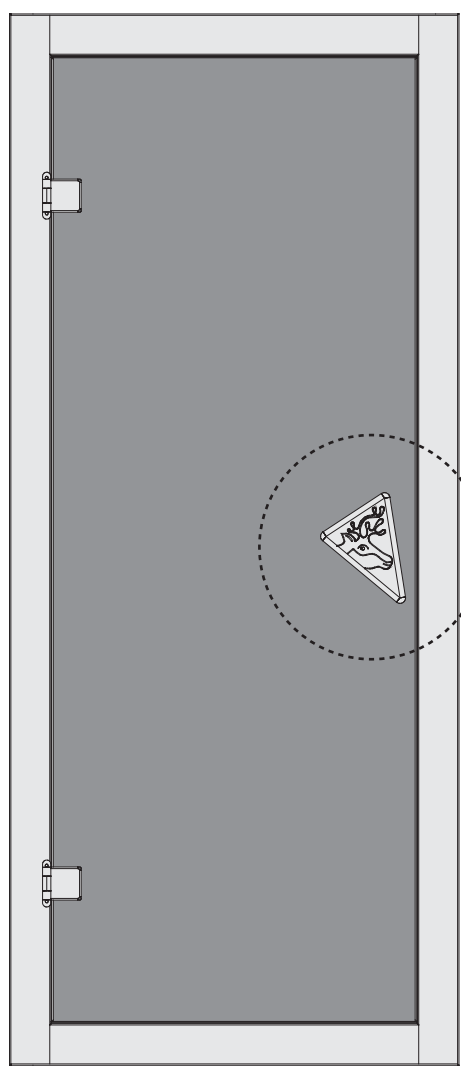
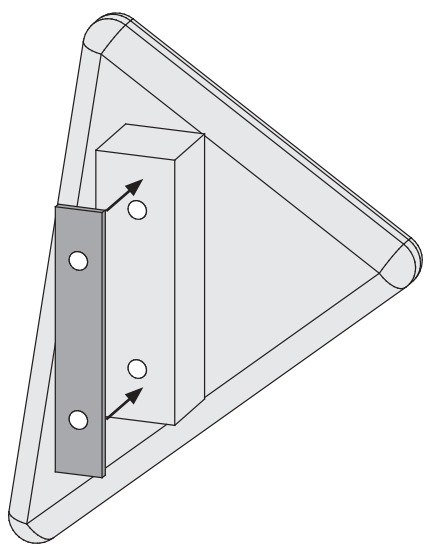

3.

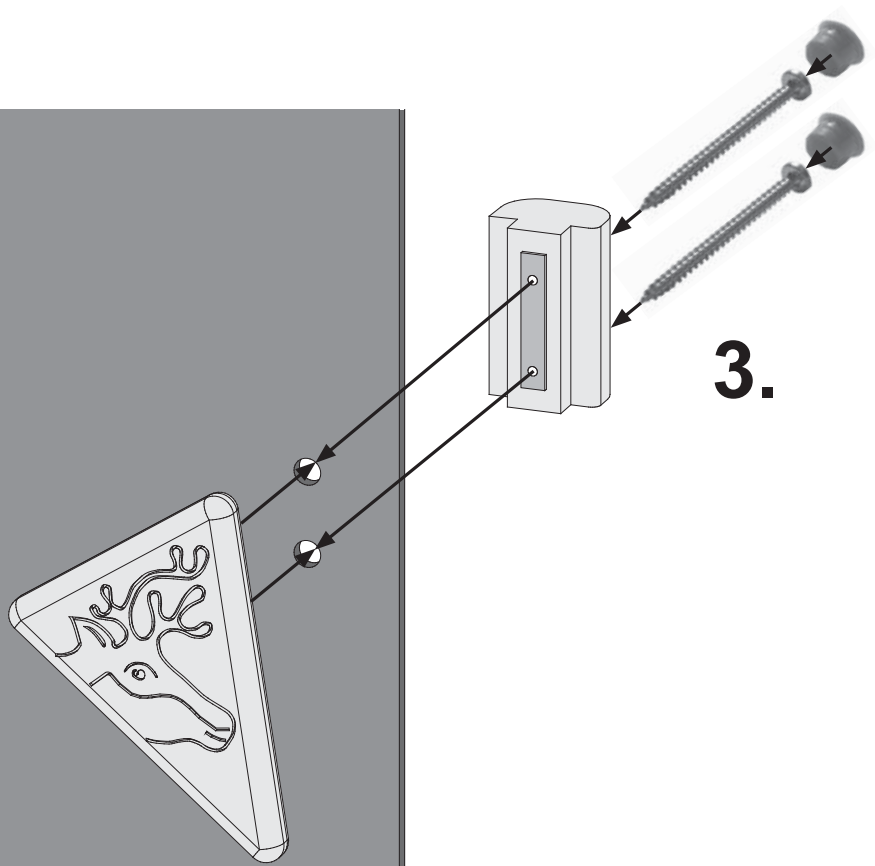

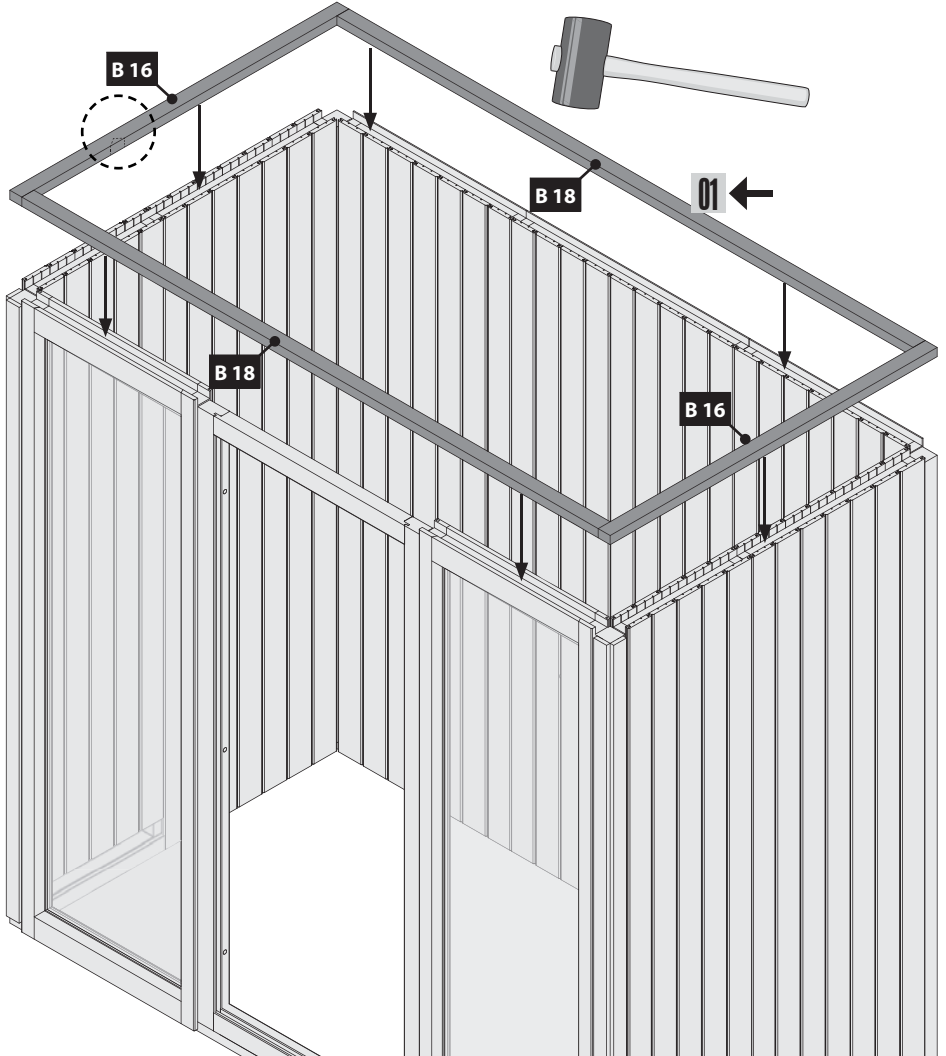
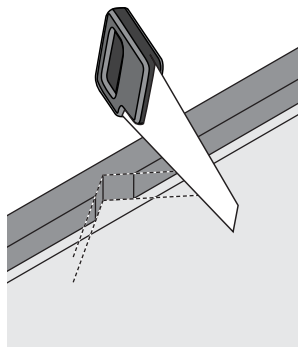

- Kabeldurchführung
- cable inlet
- entrée de câble
- Kabelindgang
- kabelingang
- entrada del cable
- ingresso cavi
- kabelová průchodka

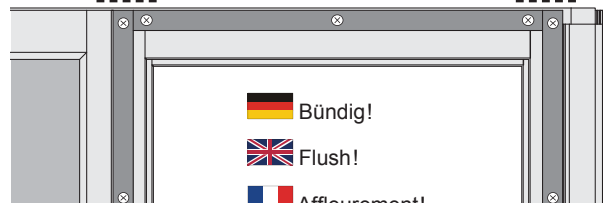
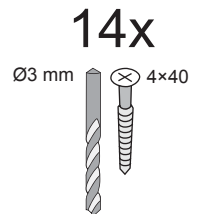
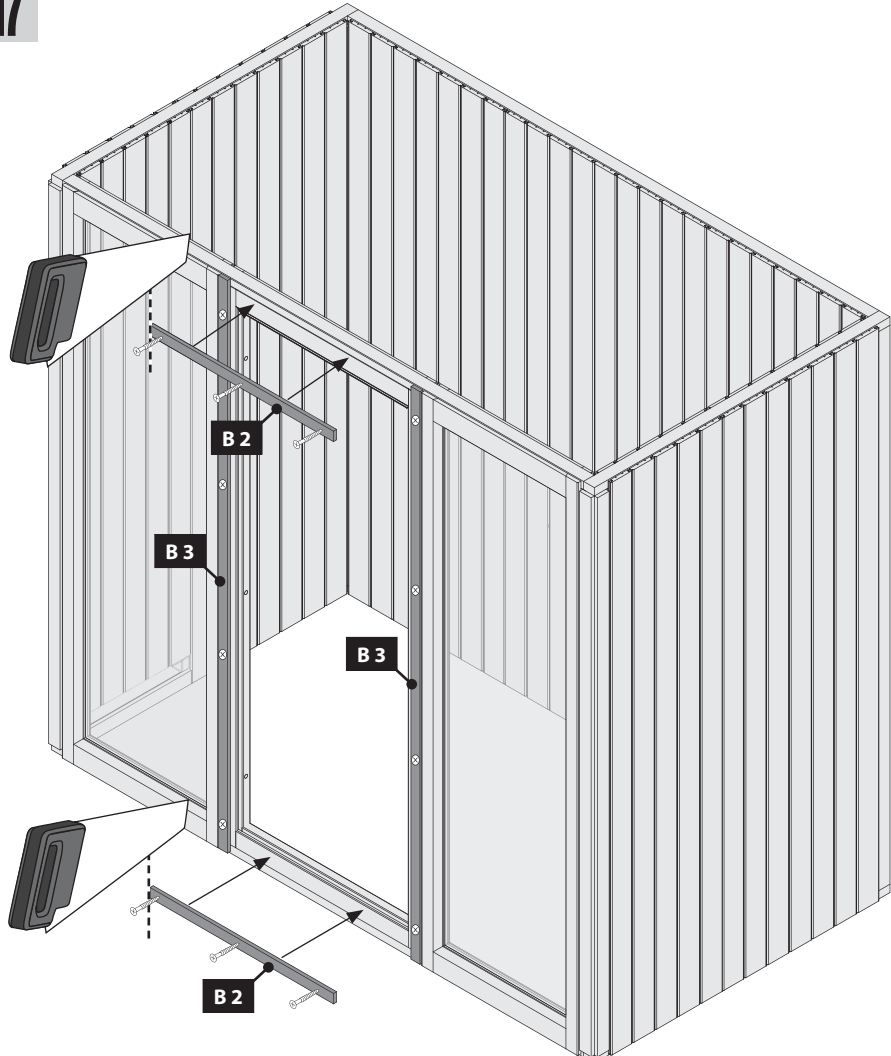

- Bündig!
- Flush!
- Affleurement!
- I flugt!
- Gelijk!
- Aras!
- Combacia!
- Stejný !

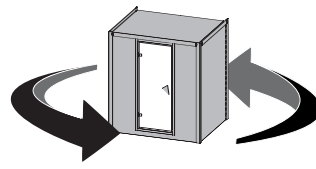

14x

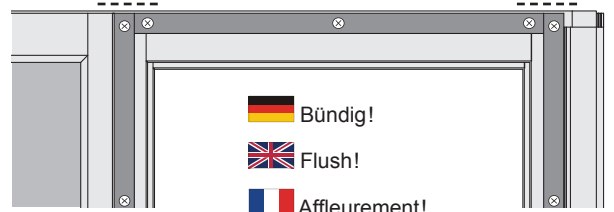
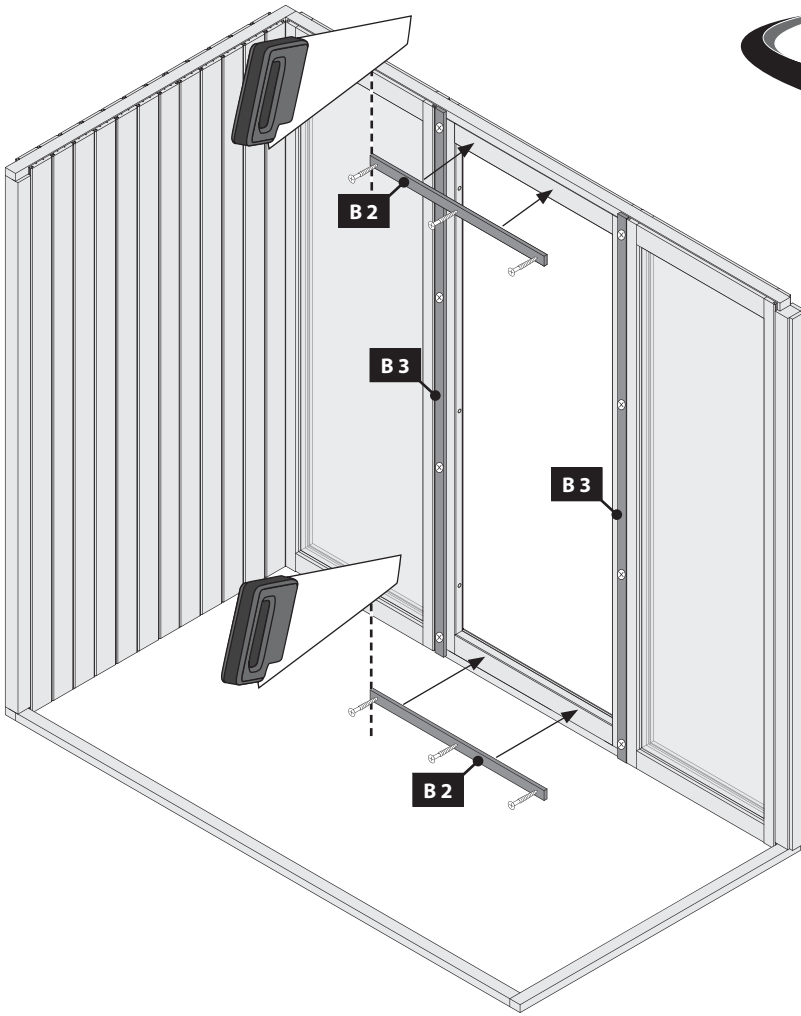
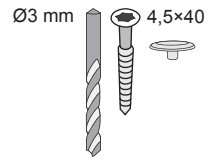

-  Bündig!
-  Flush!
-  Affleurement!
-  I flugt!
-  Gelijk!
-  Aras!
-  Combacia!
-  Stejný !

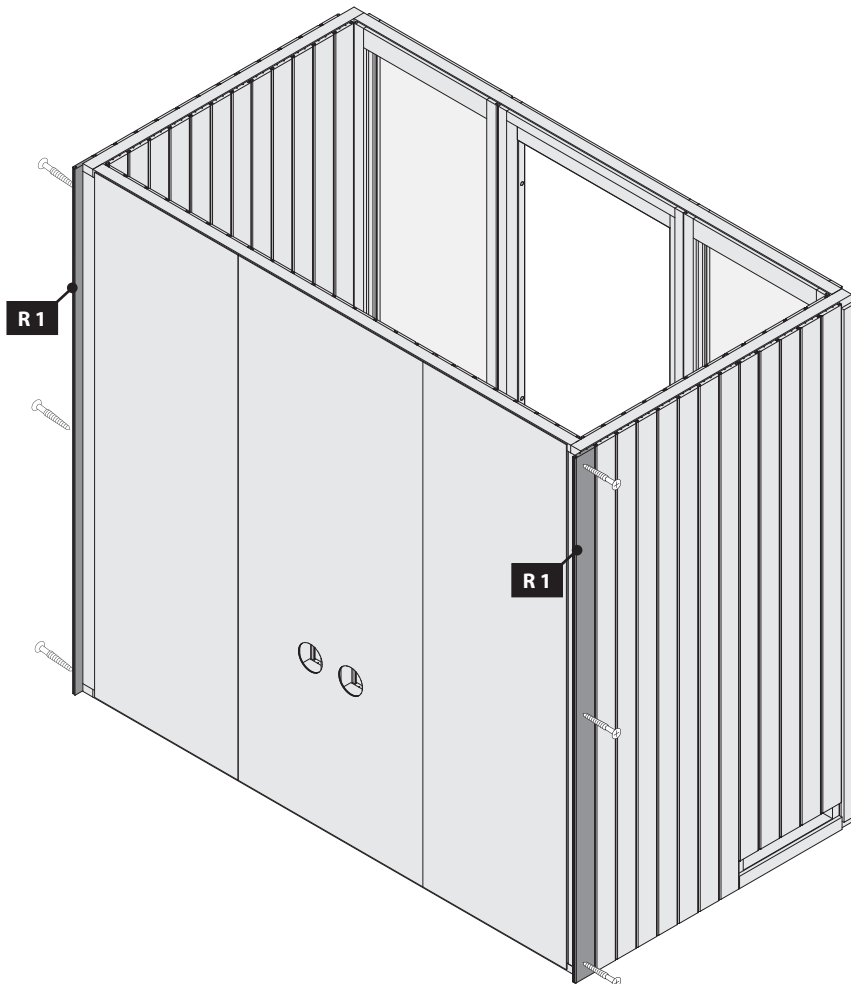

6x

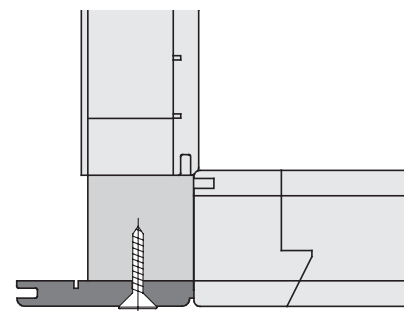
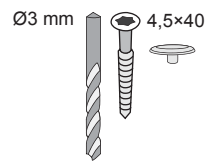

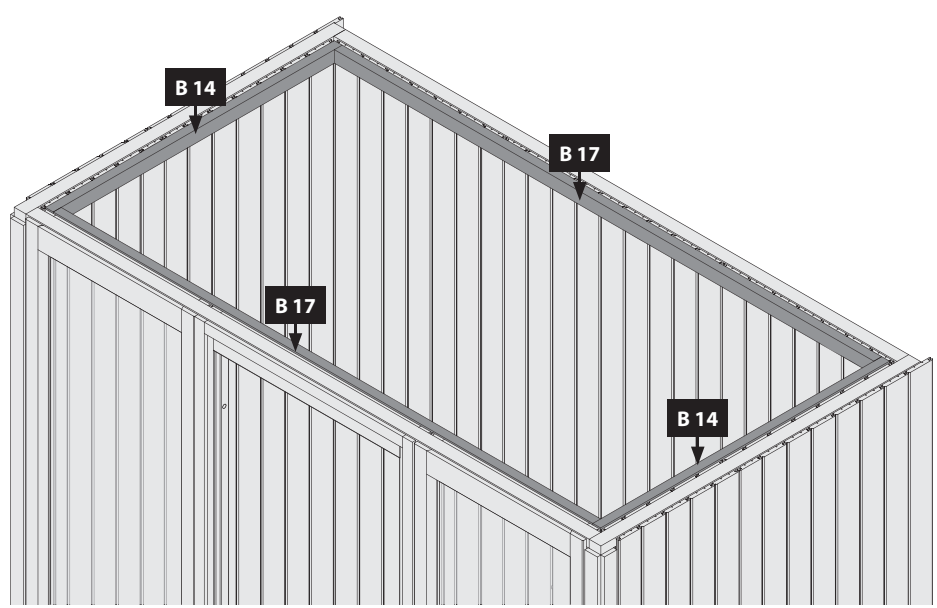
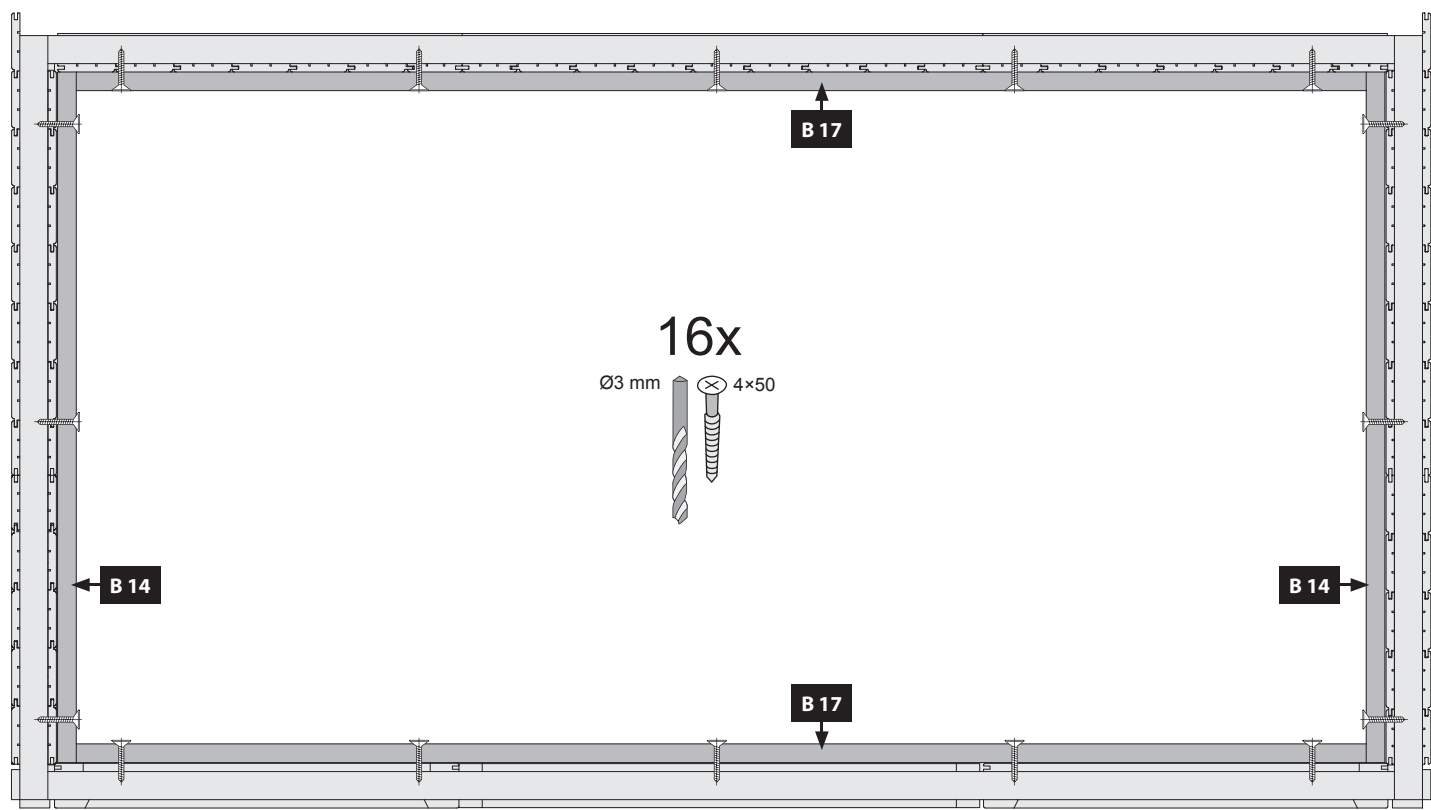

-  Sauna Dichtband
-  Sauna sealing tape
-  Ruban d'étanchéité pour sauna
-  Sauna tætningsbånd
-  Sauna afdichtingstape
-  Cinta de sellado de sauna
-  Nastro sigillante per sauna
-  Sauna těsnící páska

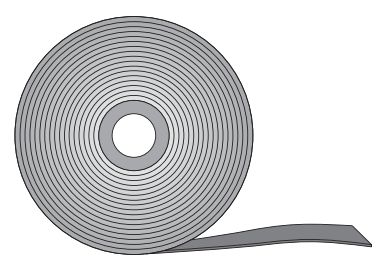
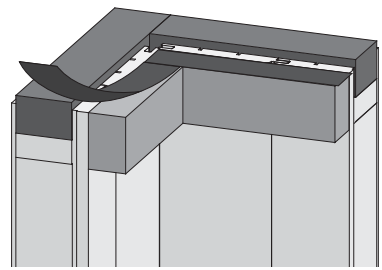

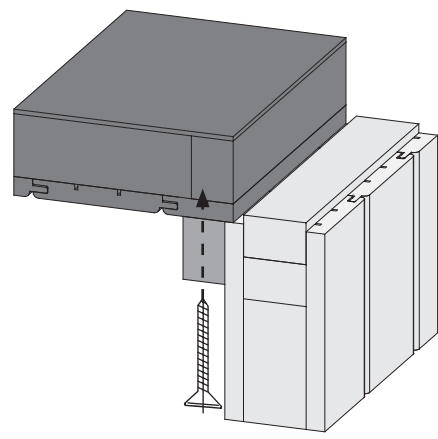
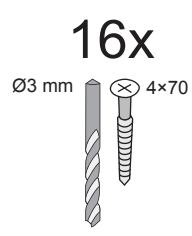
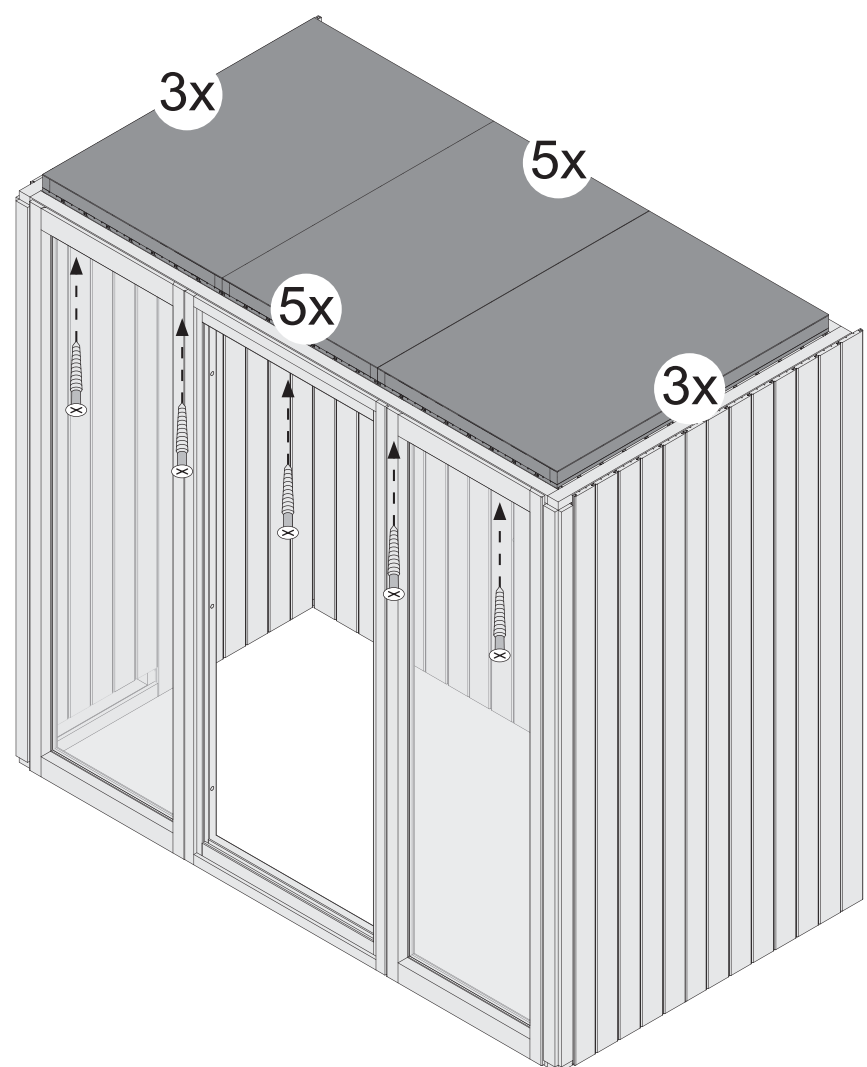
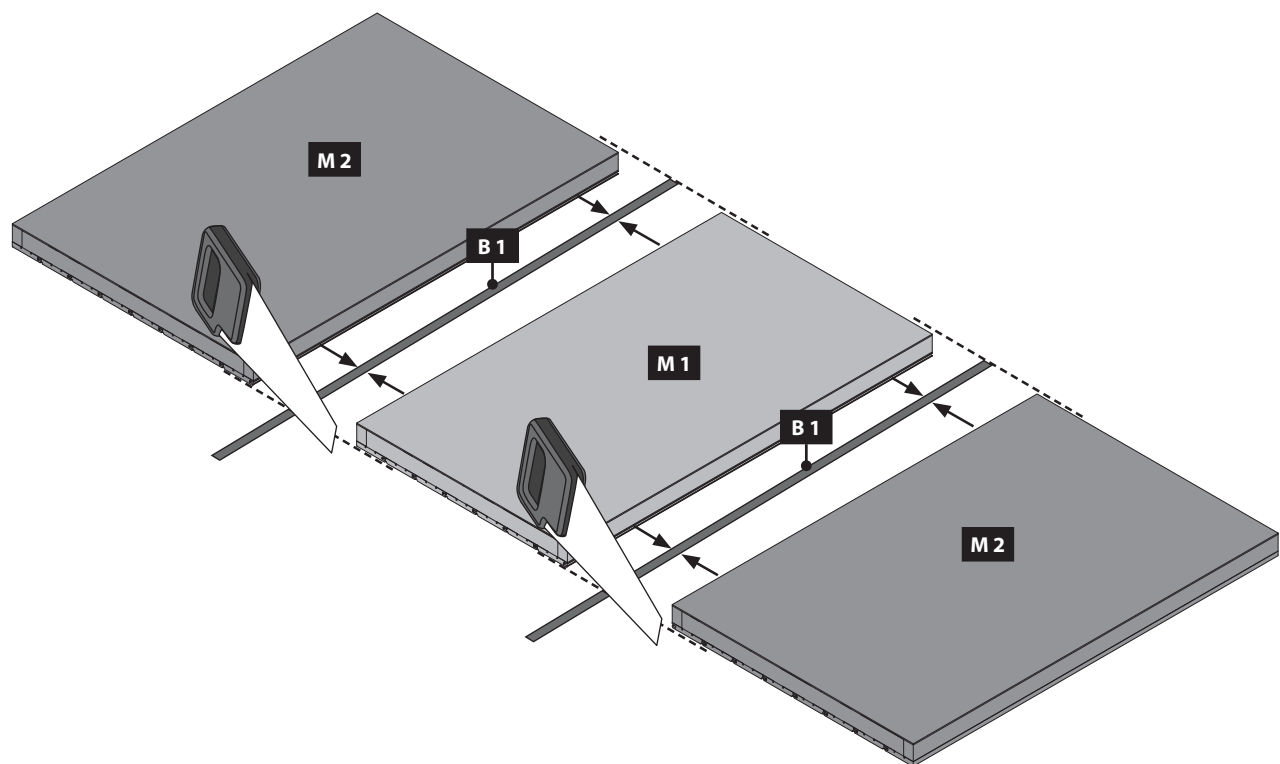



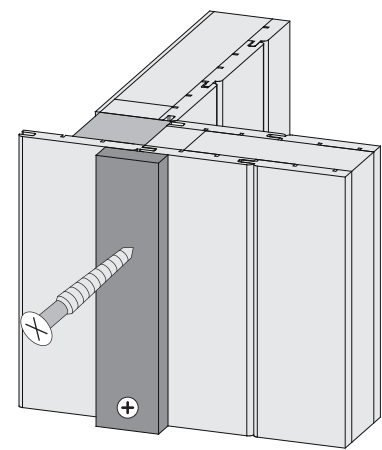
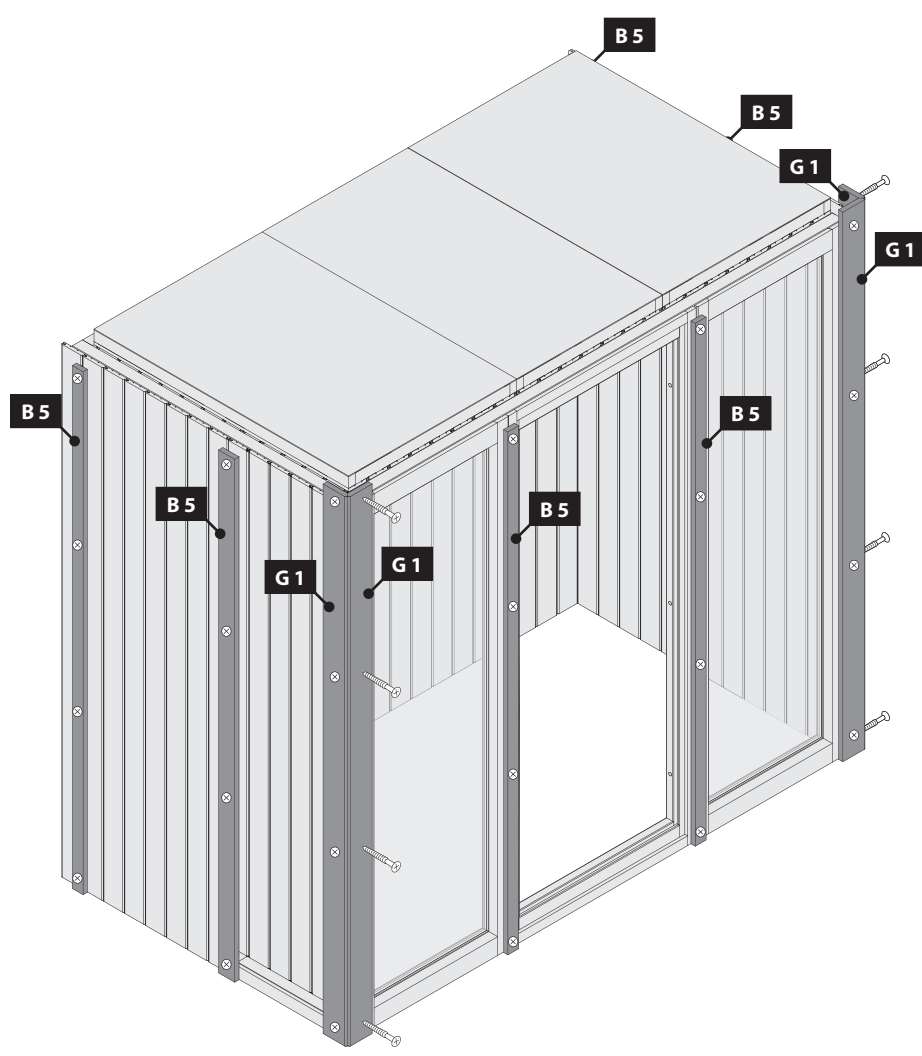
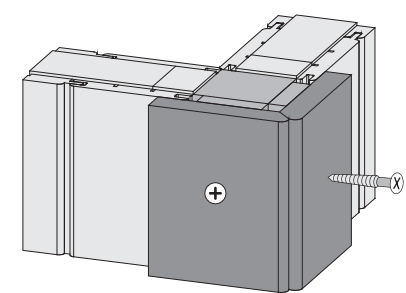
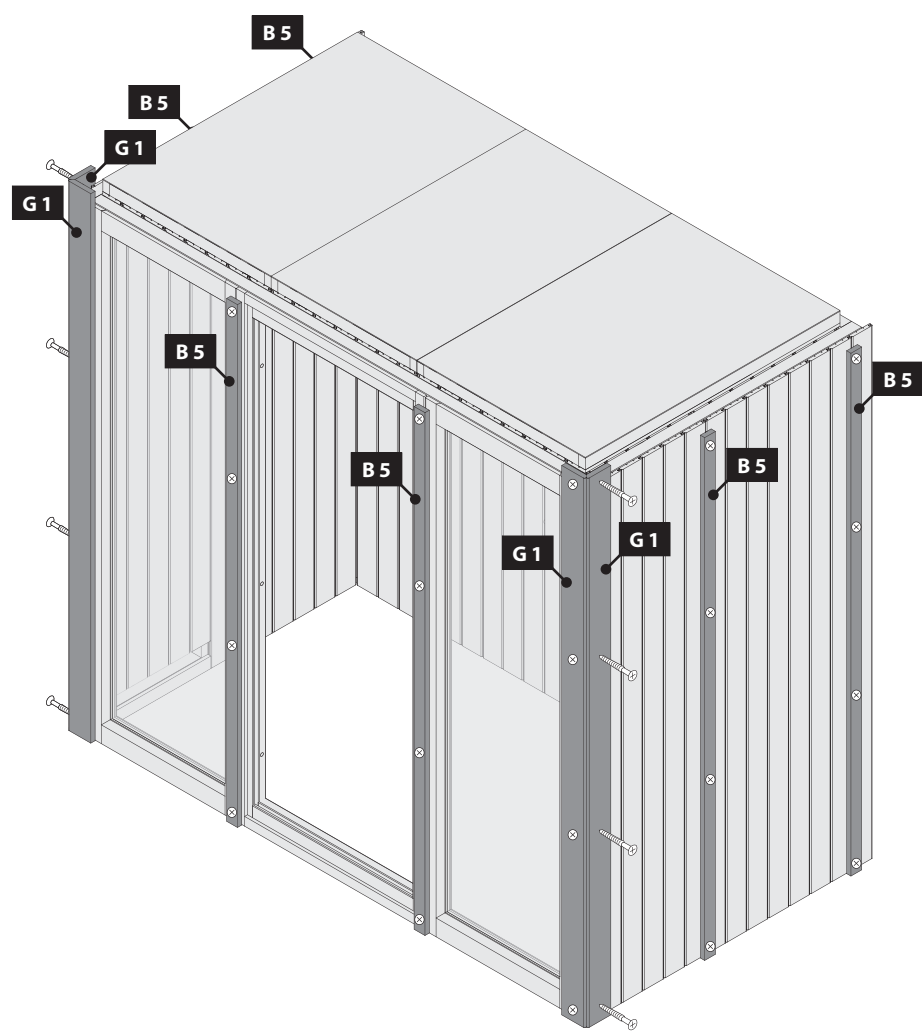
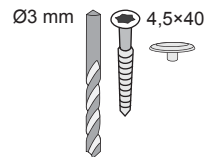

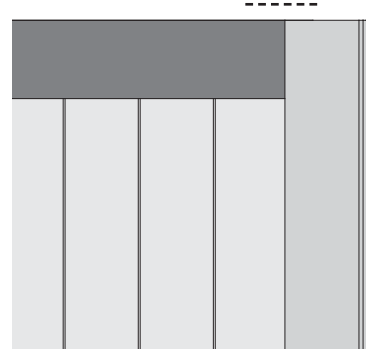
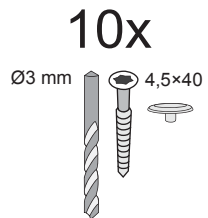
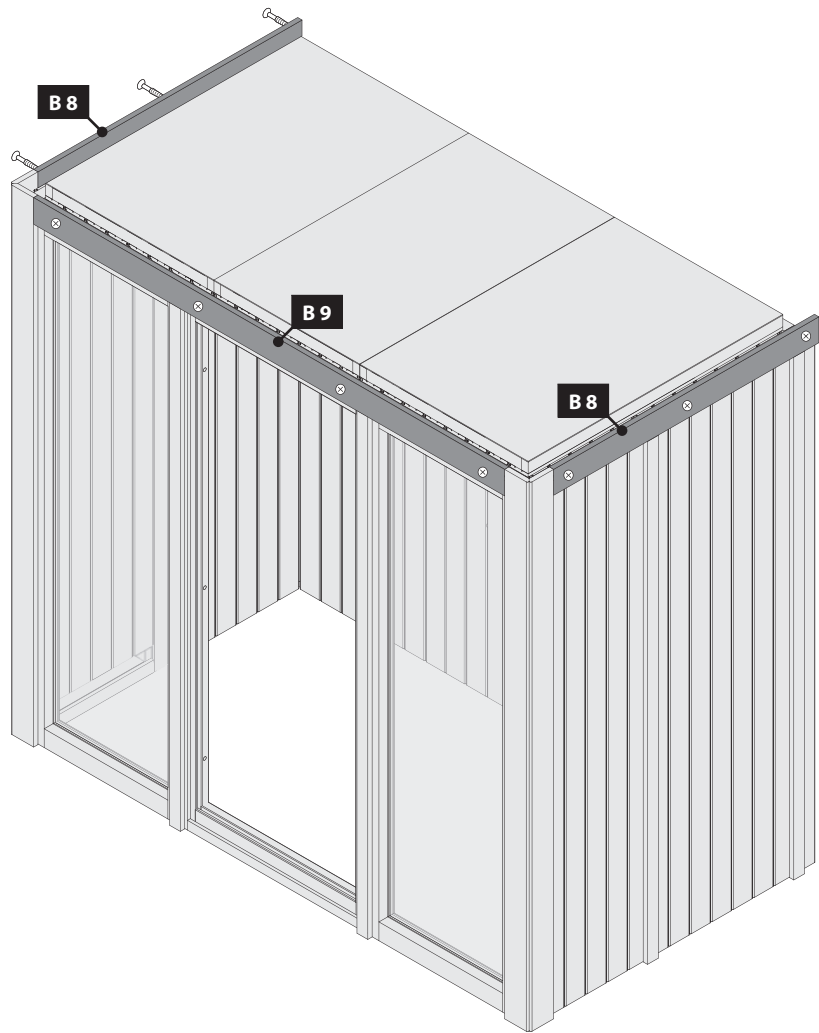

40x





- | | |
|---|---|
|  Bündig! |  Gelijk! |
|  Flush! |  Aras! |
|  Affleurement! |  Combacia! |
|  I flugt! |  Stejný ! |

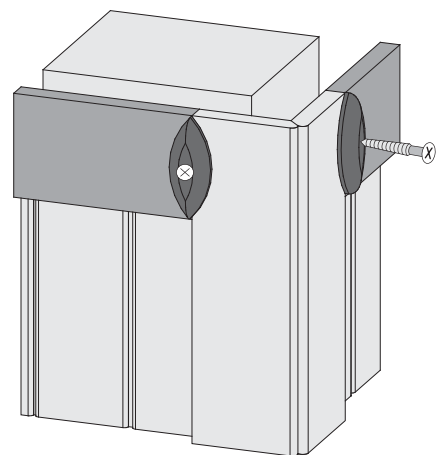
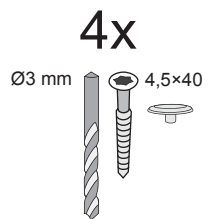
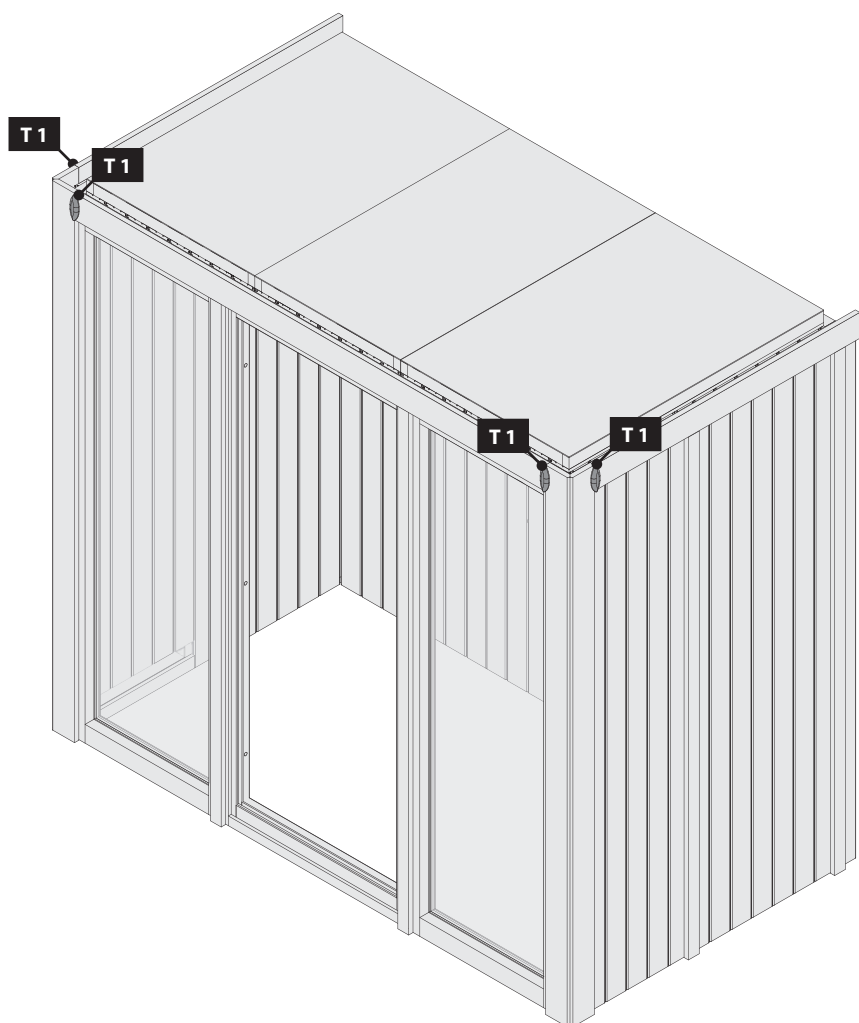

-  Ansicht innen
-  View Inside
-  Voir à l'intérieur
-  Bekijk binnen
-  Ver dentro
-  Visualizza dentro
-  Zobrazit uvnitř
-  Se inde

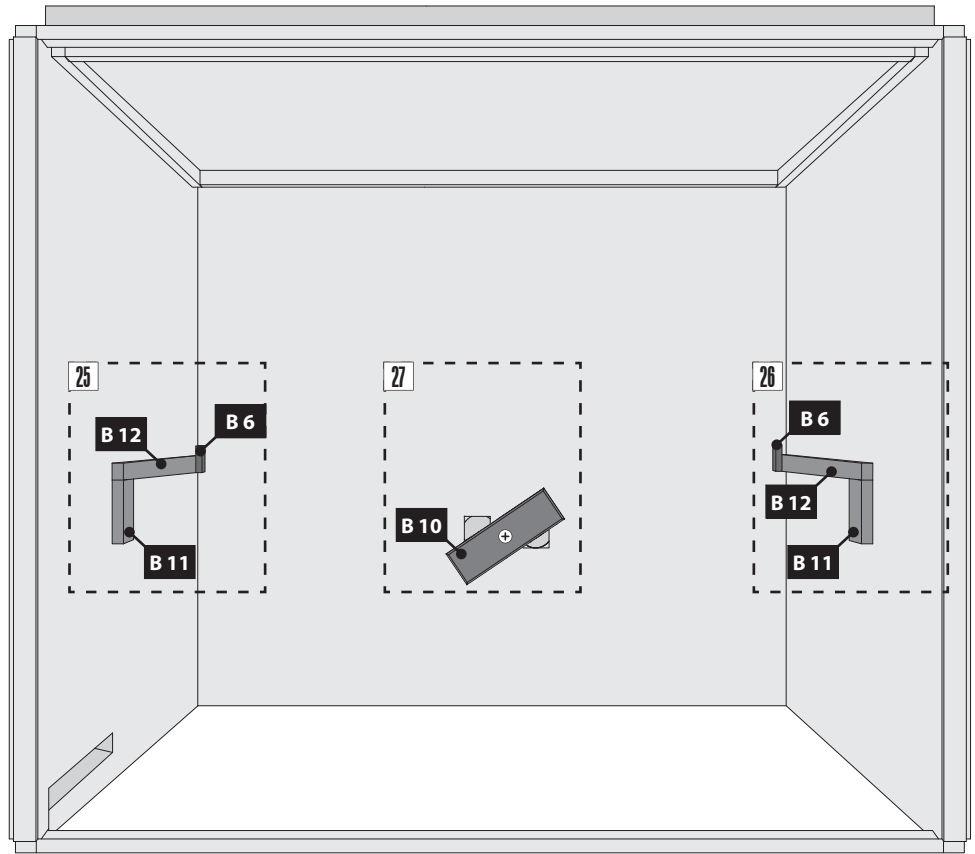

27

5x
Ø5 mm 6x60

800mm

10mm

B 12

B 11

2x
Ø3 mm 4x30

40mm

B 6

26

5x
Ø5 mm 6x60

800mm

10mm

B 12







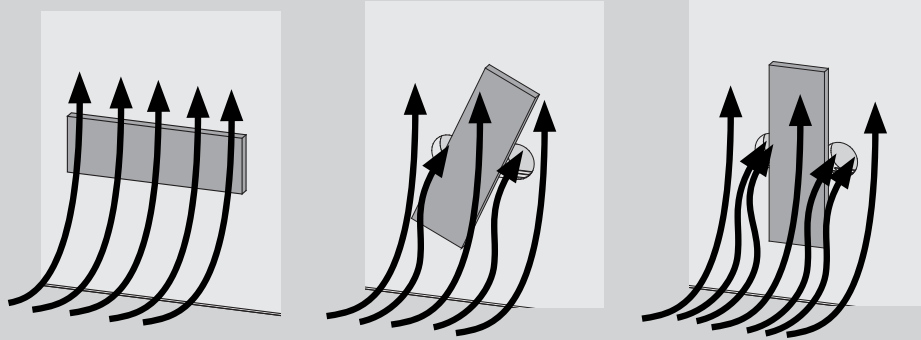
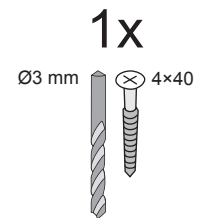
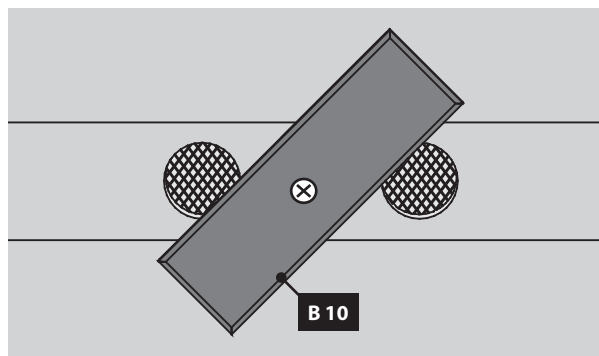

B 11

2x
Ø3 mm 4x30

40mm

B 6



-  Hier ist die Funktionsweise des Brettes abgebildet. Regeln Sie damit die Abluft nach Ihren eigenen Wünschen
-  This figure shows the functional principle of the board. Regulate the exhaust air according to your own wishes
-  Ceci représente le mode de fonctionnement de la planche. Avec elle, réglez l'écoulement de l'air selon vos désirs
-  Hier is de werking van het plankje afgebeeld. Regel daarmee de luchtafvoer naar eigen wens
-  Sådán fungerer styret. Brug den til at regulere udstødningsluften efter dine egne ønsker
-  Aquí está representada la forma de funcionamiento de la tabla. Regule con ello el aire de salida según sus propios deseos
-  Viene illustrato il principio di funzionamento della tavoletta di regolazione della ventilazione. Con essa si può regolare a piacere la ventilazione
-  Zde je zobrazená funkce desky. Regulujte s ní odsávací vzduch dle Vašeho přání

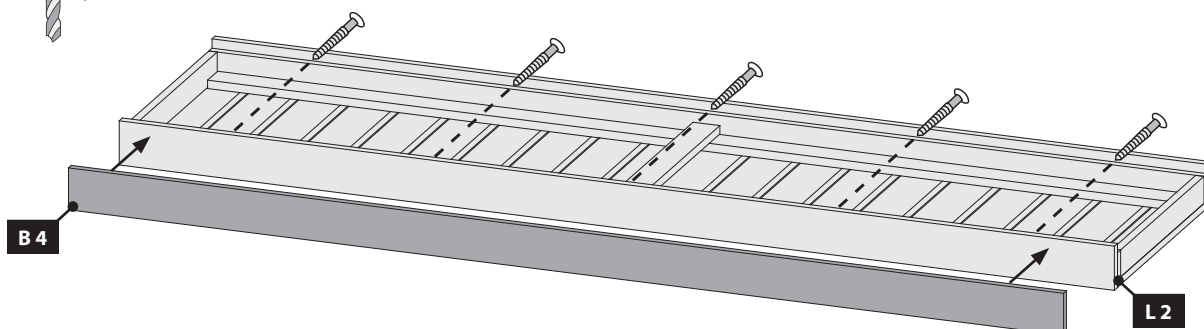
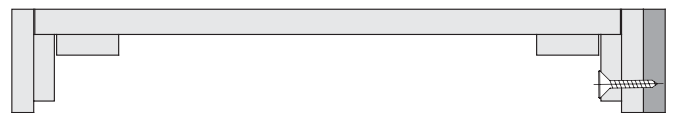
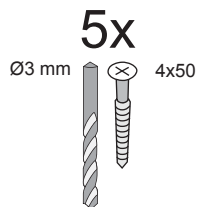

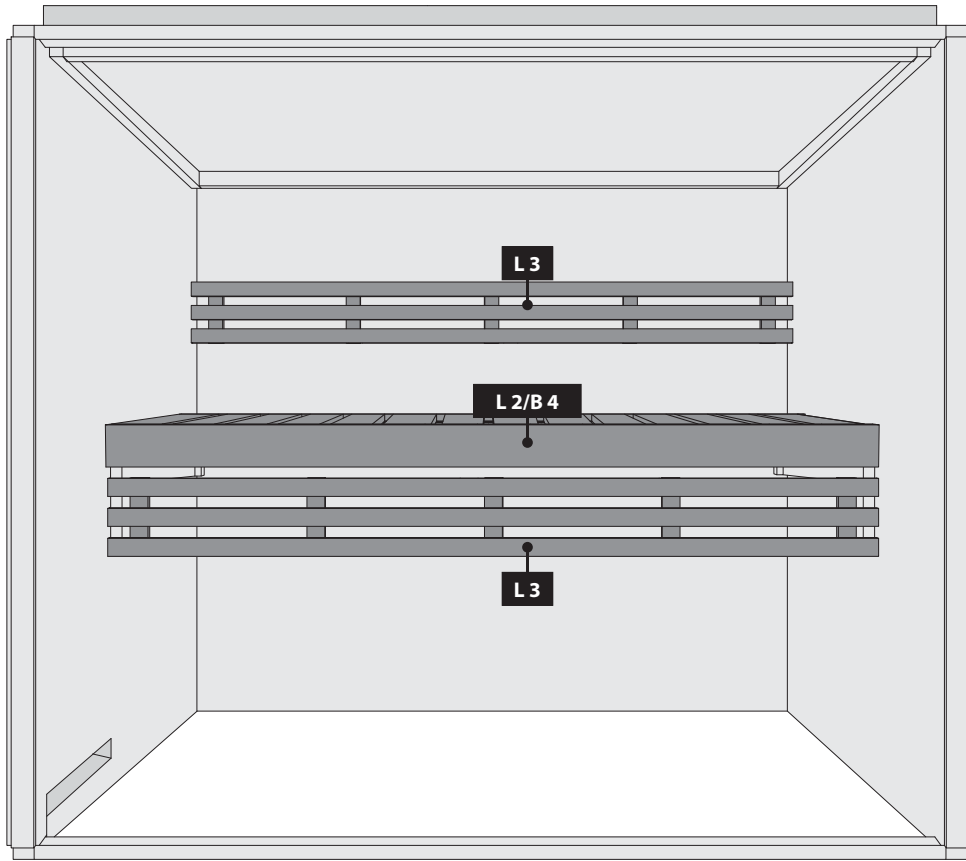

20x

Ø3 mm

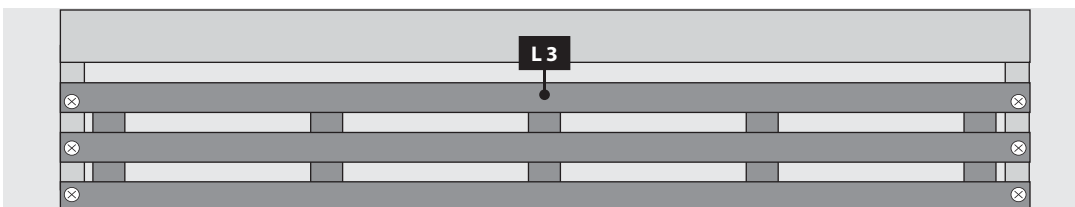
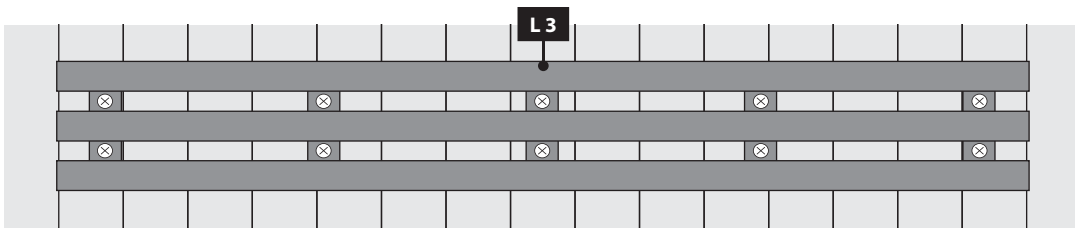
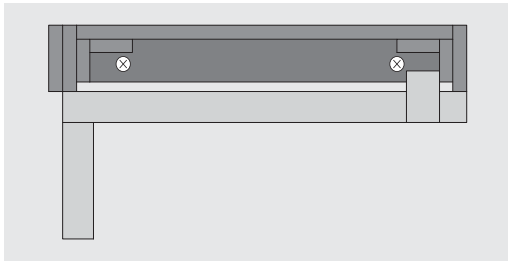
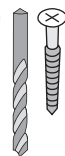

31

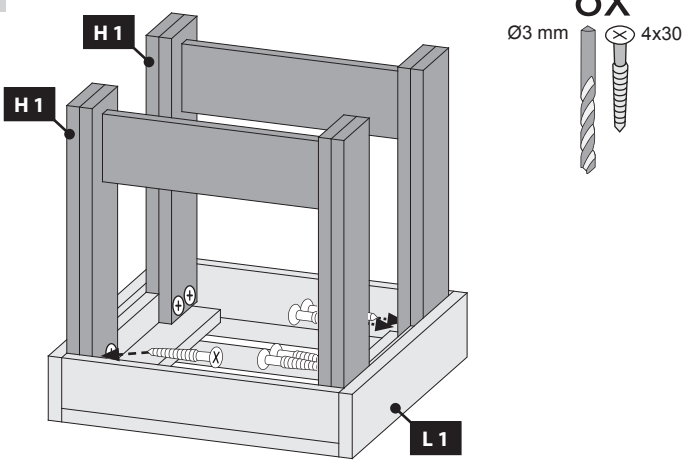

33

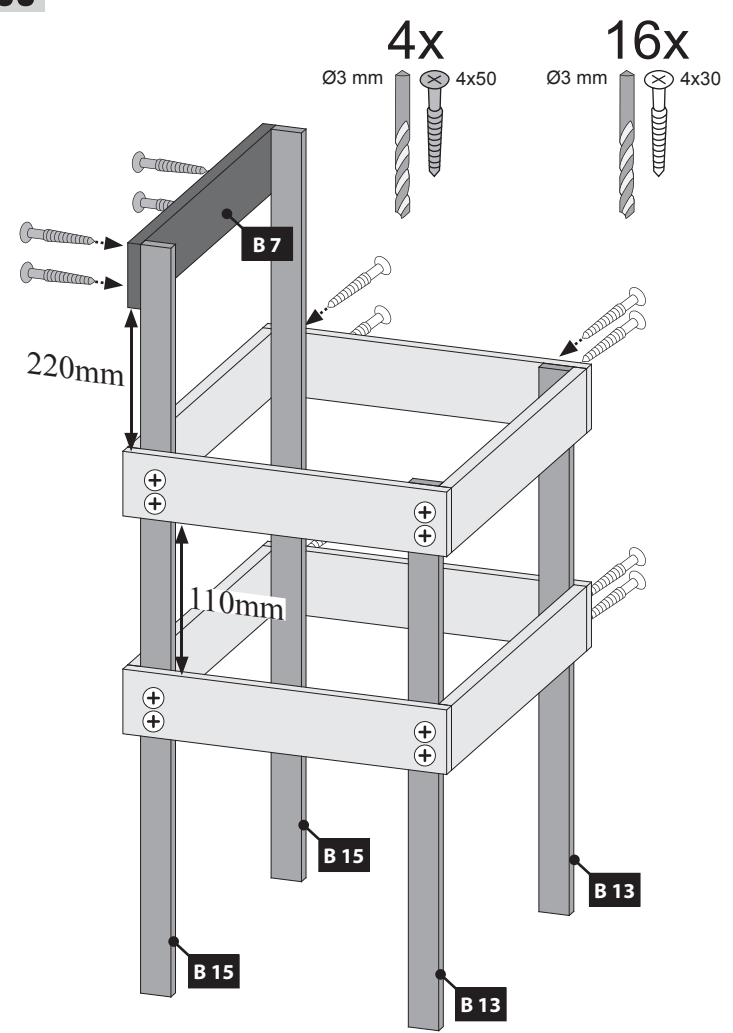

32

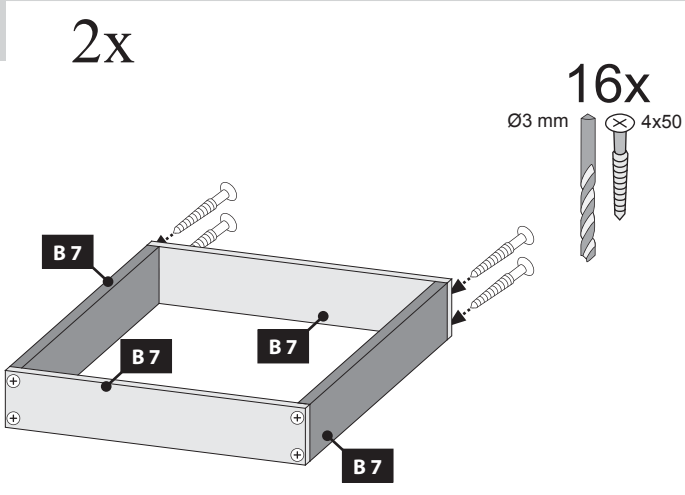

34

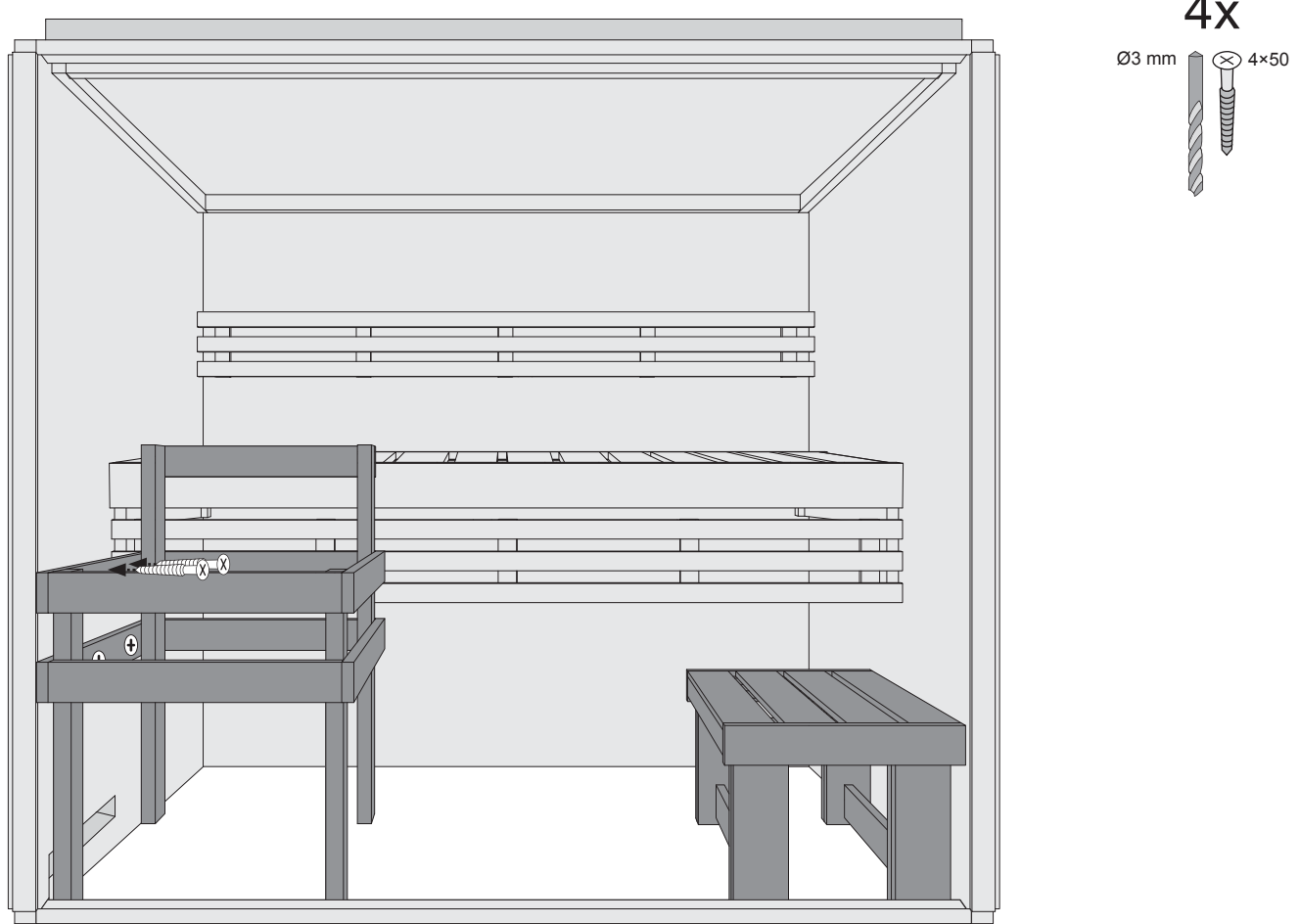

Exemplarische Kabelverlegung

Saunatyp	68mm
Steuerung	extern

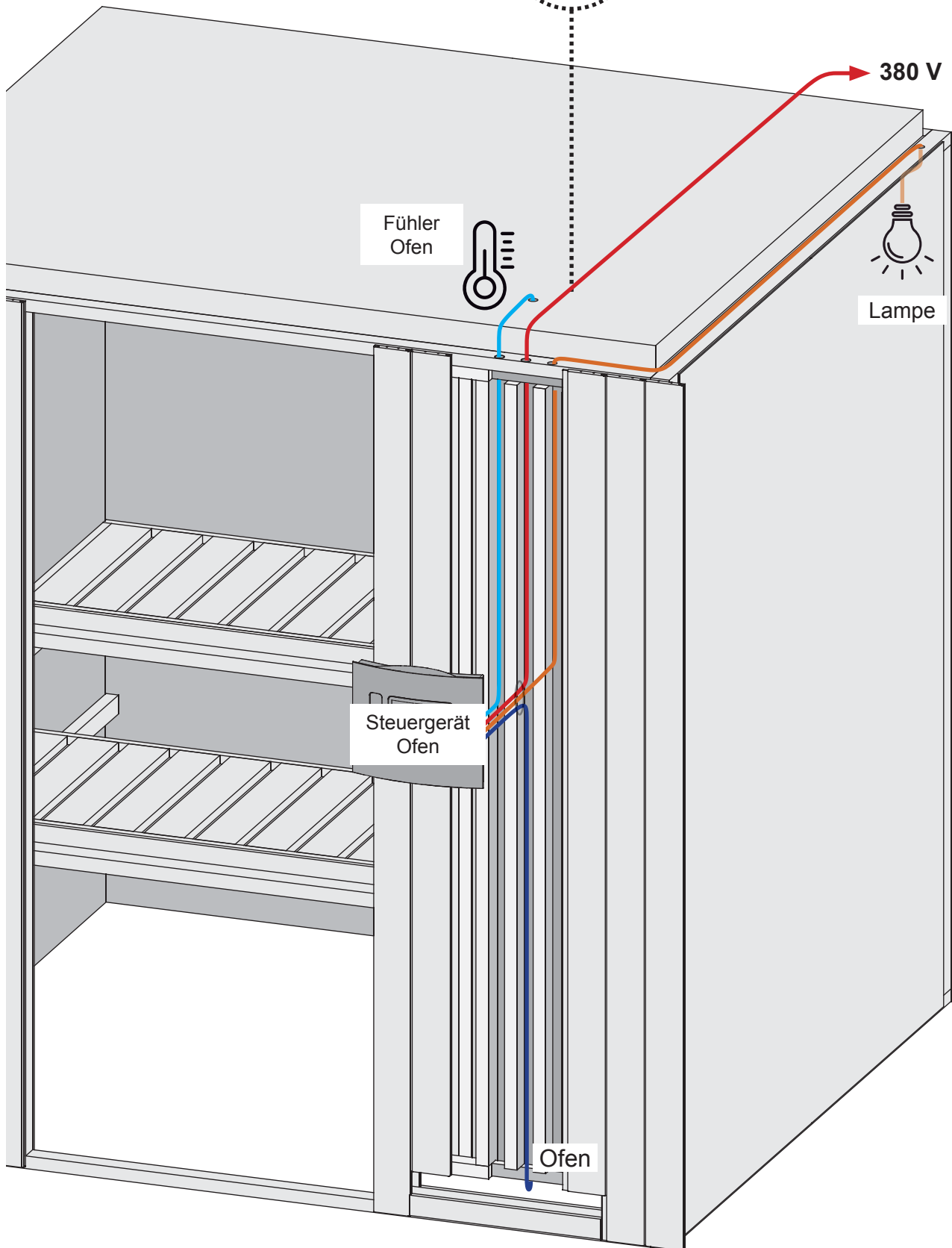
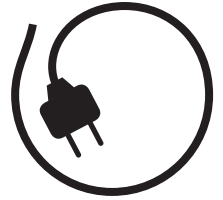
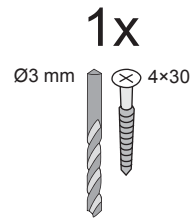

Exemplarische Kabelverlegung

Saunatyp	68mm
Steuerung	integriert

