

Art.Nr. 443093 - Panama
1/8

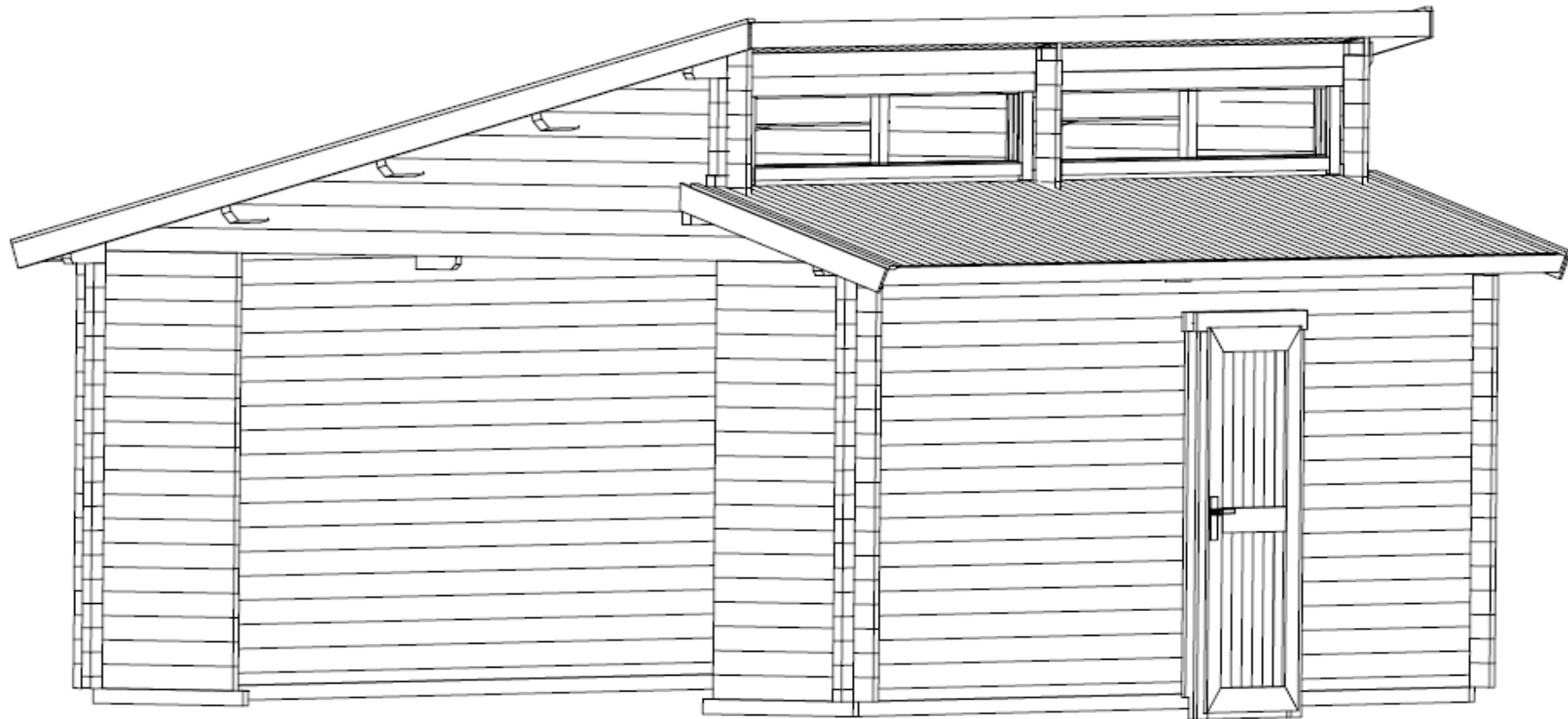

Art.Nr. 443093

GROUNDPLAN - GRUNDPLAN - PLAN DE MASSE

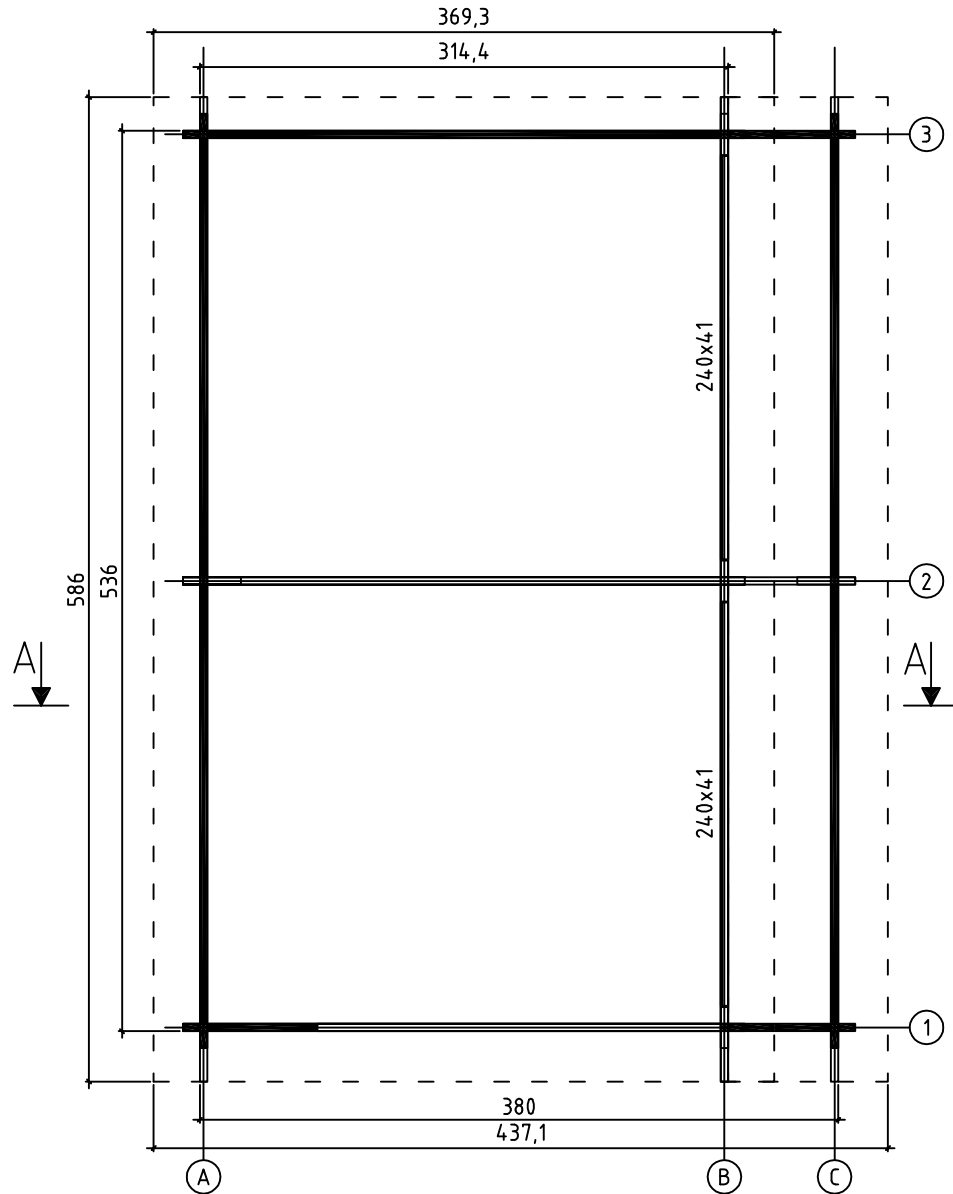

FOUNDATION - FUNDAMENT - FONDATION

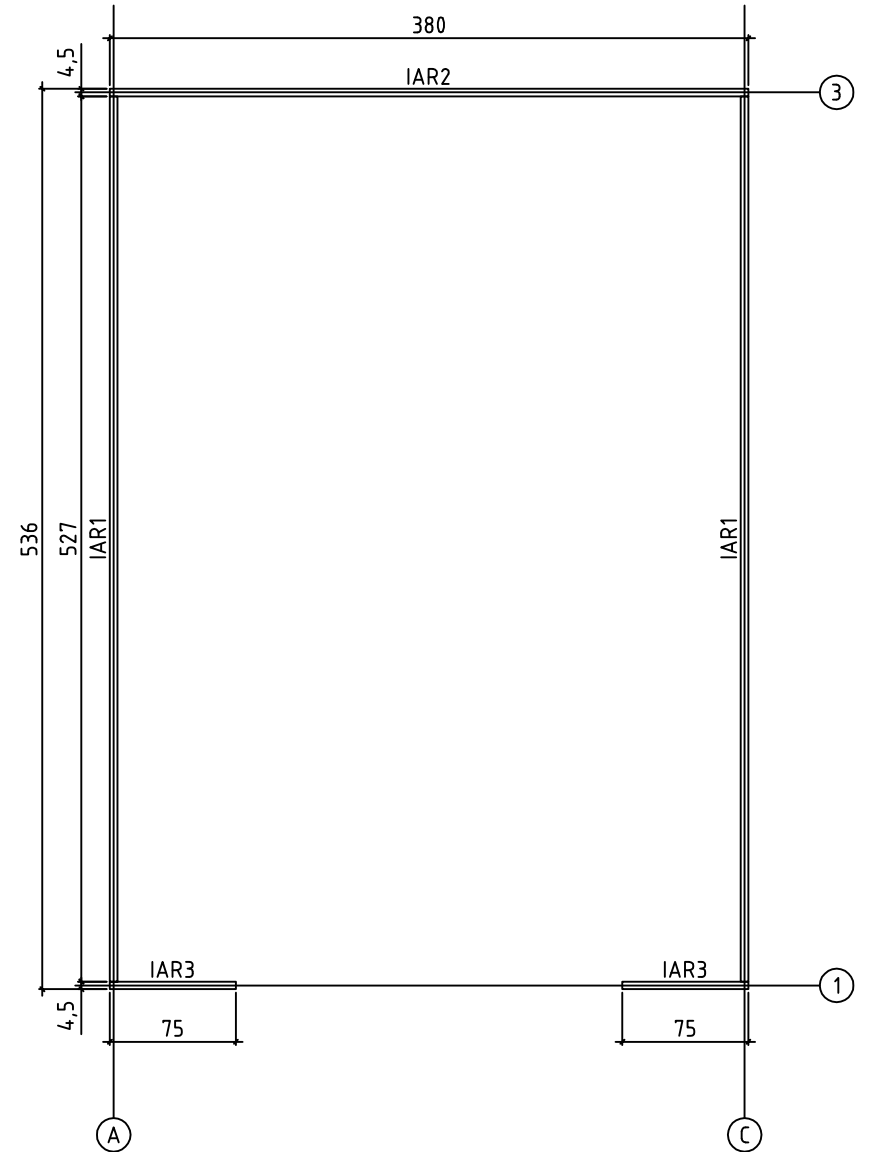

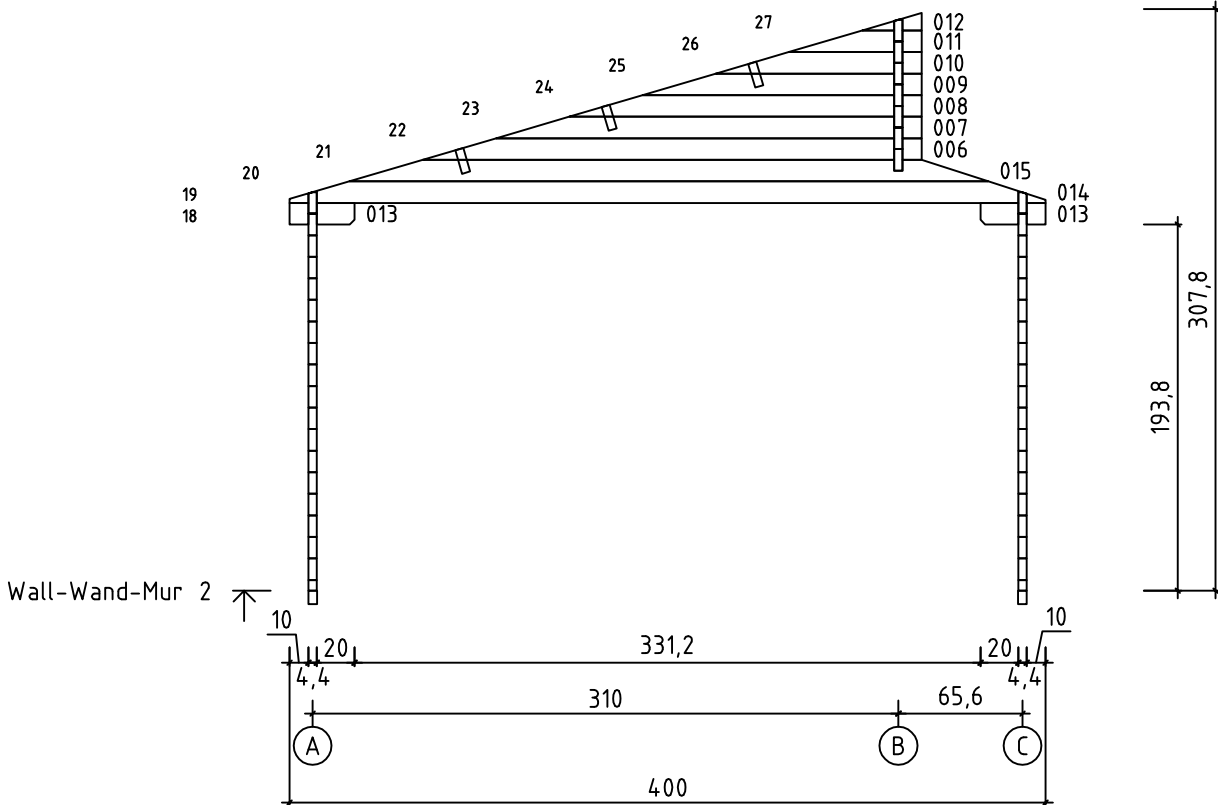
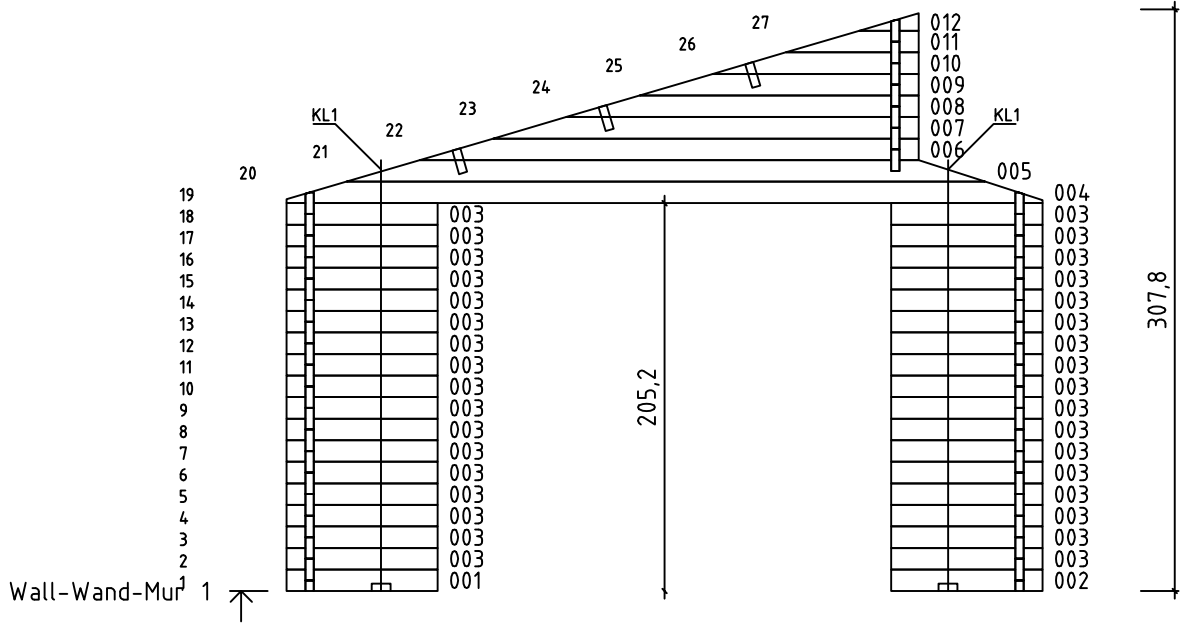

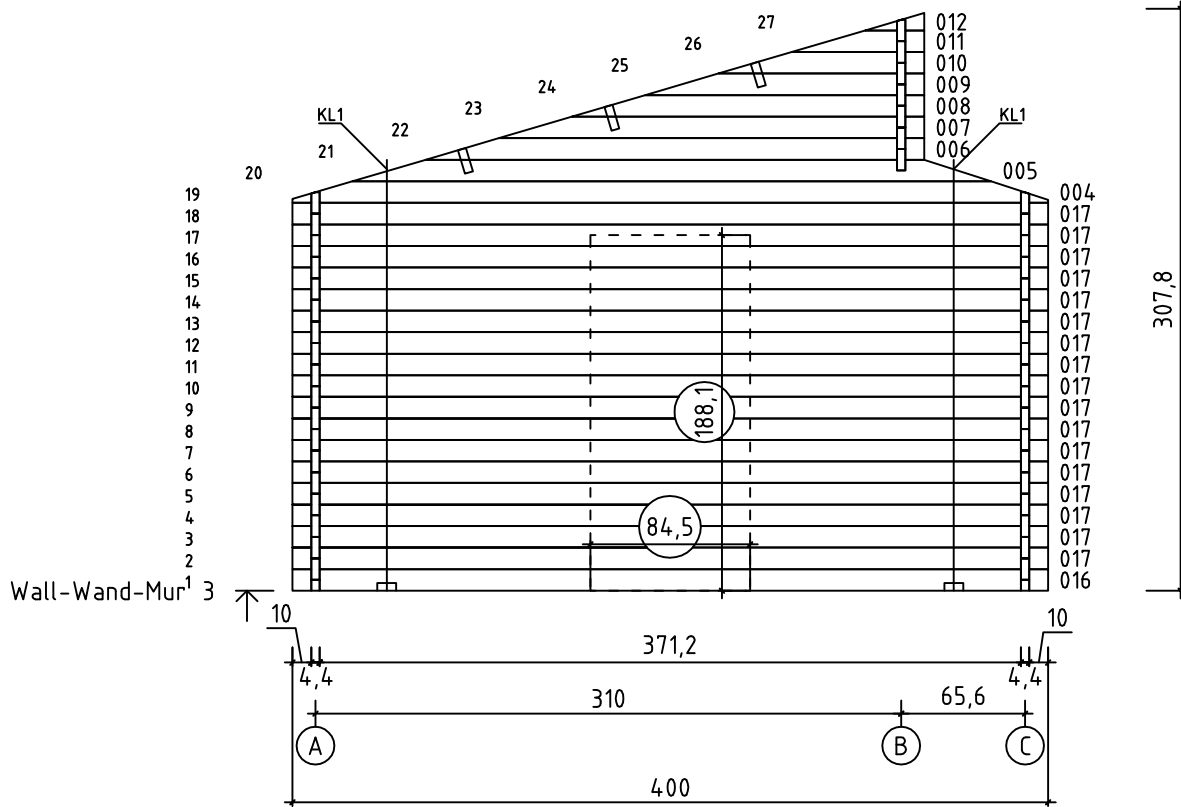

A SINGLE DOOR (83.5 X 185 CM) HAS BEEN DELIVERED TOGETHER WITH THE BUILDING. YOU CAN CHOOSE THE LOCATION FOR THE DOOR BY YOURSELF BY CUTTING THE WALL LOGS AS SHOWN IN THE PICTURE (SEE THE DOTTED LINE)

IM LIEFERUMFANG IST EINE EINZELTÜR SOWIE EIN EINZELFENSTER ENTHALTEN. DAFÜR SIND ABER WERKSSEITIG KEINE AUSSPARUNGEN VORGESEHEN SO DASS SIE SOWOHL FENSTER ALS AUCH TÜR INDIVIDUELL VERBAUEN KÖNNEN. EINE ANLEITUNG HIERFÜR ENTNEHMEN SIE BITTE DER MONTAGEANLEITUNG (SIEHE BILD)





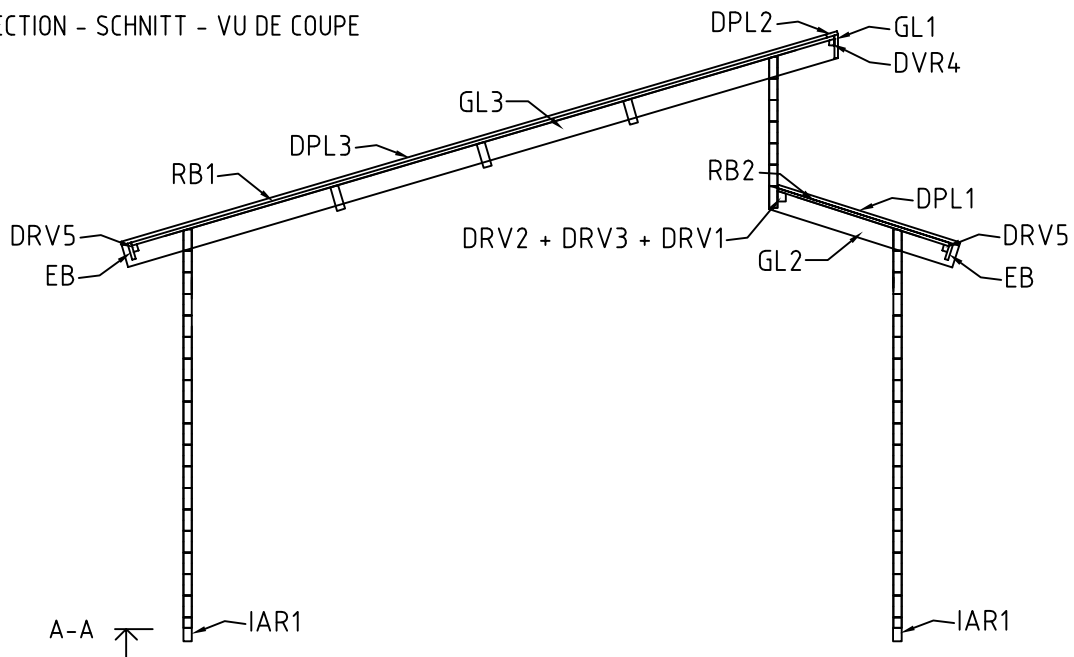

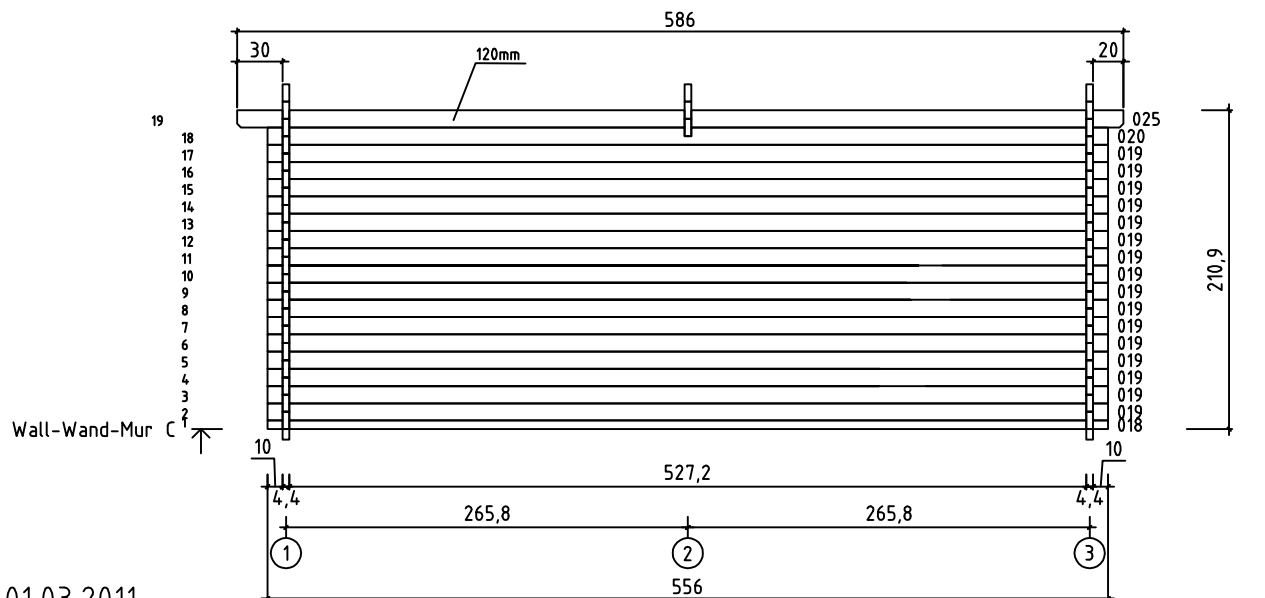
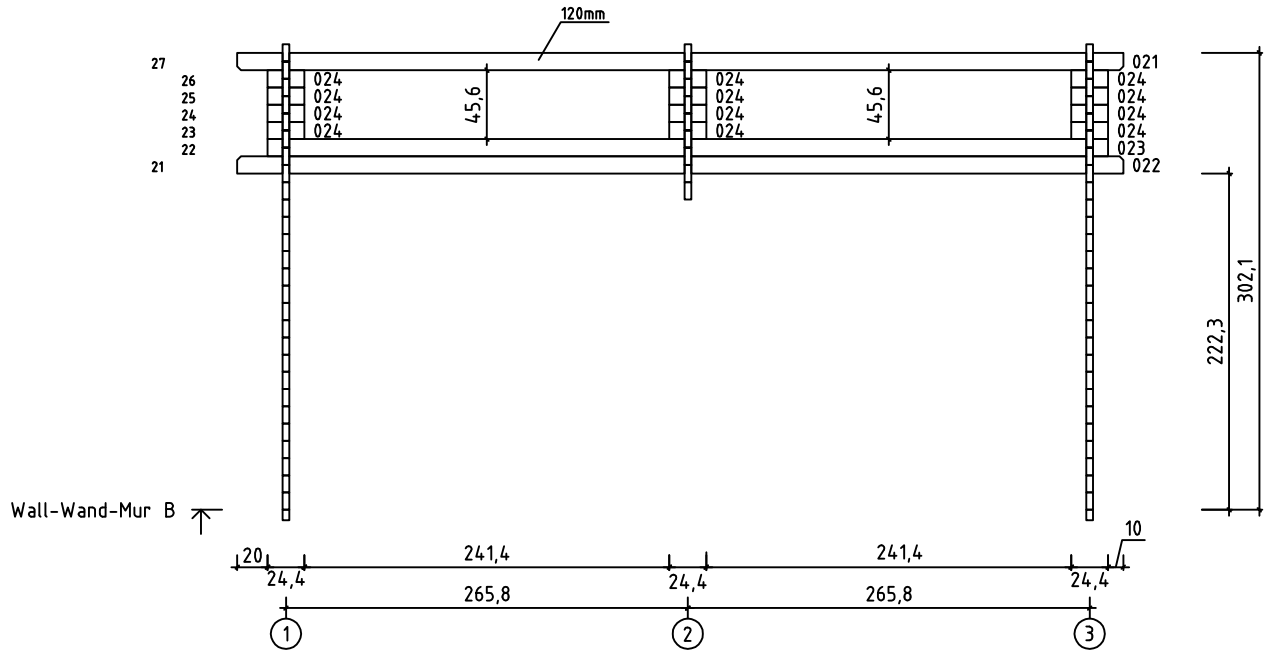
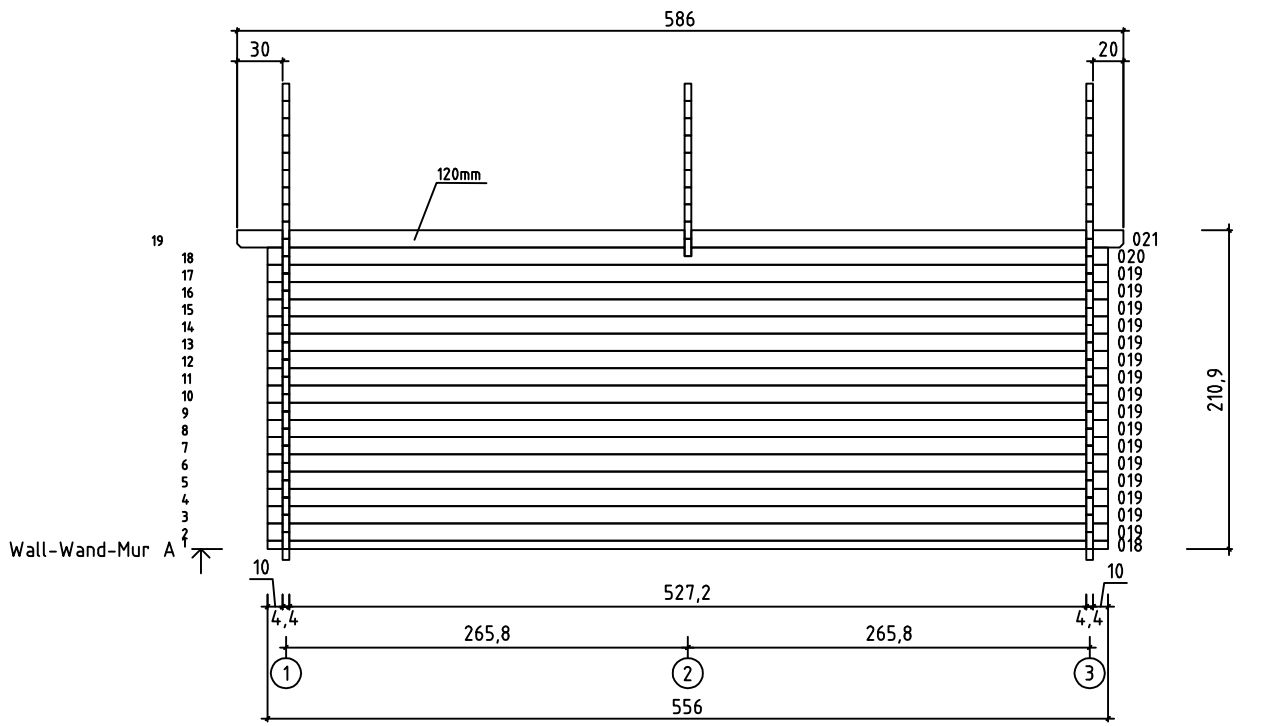





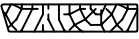

LE POSITIONNEMENT DE LA PORTE DE SERVICE NÉCESSITE LA DÉCOUPE PRÉALABLE DES MADRIERS. VEILLEZ RESPECTER LES COTES DE DÉCOUPES DANS LES MADRIERS INDIQUÉES SUR LE SCHÉMA. VOUS POUVEZ POSITIONNER, SELON VOTRE CONVENANCE, LES OUVERTURES DE CHAQUE CÔTÉ OU À L'ARRIÈRE DU GARAGE.

CROSS SECTION - SCHNITT - VU DE COUPE

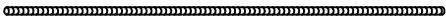
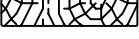

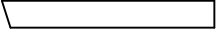
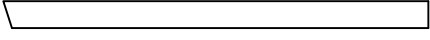

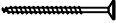
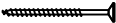
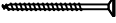
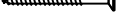
Pos	01.03.2011	Piecelist - Stücklist - Liste des composants Art.Nr. 443093	6/8	Q.	P. (mm)	L. (mm)
001				1	44x114	800
002				1	44x114	800
003				34	44x114	800
013				2	44x114	344
016				1	44x114	4000
017				17	44x114	4000
018				2	44x57	5560
019				32	44x114	5560
020				2	44x114	5560
021				2	44x120	5860
022				1	44x114	5860
023				1	44x114	5560
024				12	44x114	244
025				1	44x120	5860
W1-1 W3-1				2		
W2-1				1		
IAR1	FOUNDATION - FUNDAMENT - FONDATION			2	45x70	5270
IAR2	FOUNDATION - FUNDAMENT - FONDATION			1	45x70	3800
IAR3	FOUNDATION - FUNDAMENT - FONDATION			2	45x70	750
APR1	ROOF BEAM - DACHBALKEN - PANNE DE TOIT			3	44x140	5860
RB1	ROOF BOARDS - DACHBRETTER - VOLIGES			66	90x18	3850

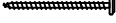
Pos	01.03.2011	Piecelist - Stücklist - Liste des composants Art.Nr. 443093	7/8	Q.	P. (mm)	L. (mm)
RB2	ROOF BOARDS - DACHBRETTER - VOLIGES			66	90x18	1000
DRV1	ROOF EDGE REINFORCEMENT - DACHRANDVERSTÄRKUNG BARRE DE RENFORT D'EXTREMITE DU PAN DE TOITURE INFERIEURE			1	44x57	200
DRV2	ROOF EDGE REINFORCEMENT - DACHRANDVERSTÄRKUNG BARRE DE RENFORT D'EXTREMITE DU PAN DE TOITURE INFERIEURE			1	44x57	300
DRV3	ROOF EDGE REINFORCEMENT - DACHRANDVERSTÄRKUNG BARRE DE RENFORT D'EXTREMITE DU PAN DE TOITURE INFERIEURE			2	44x57	2612
DRV4	ROOF EDGE REINFORCEMENT - DACHRANDVERSTÄRKUNG - CORNIERE DE RENFORT DE BORD DE TOIT			2	28x34	2930
GL1	GABLE MOULDING - GIBELLEISTE - PLANCHE DE RIVE			2	18x120	2930
DPL1	ROOFING FELT FILLET - DACHPAPPENLEISTE - BAGUETTE DE FIXATION DU FEUTRE BITUMEUX			2	18x58	1008
DPL2	ROOFING FELT FILLET - DACHPAPPENLEISTE - BAGUETTE DE FIXATION DU FEUTRE BITUMEUX			2	18x58	2890
DPL3	ROOFING FELT FILLET - DACHPAPPENLEISTE - BAGUETTE DE FIXATION DU FEUTRE BITUMEUX			2	18x58	3900
KL1	TREADED ROD M10 - GEWINDESTANGE M10 - TIGE FILETÉE M10			4		200
KL1	TREADED ROD M10 - GEWINDESTANGE M10 - - TIGE FILETÉE M10			4		2000
EB	EAVES BOARD - TRAUFBRETT - BANDEAU DE TOIT			4	18x90	2930
DRV5	ROOF EDGE REINFORCEMENT - DACHRANDVERSTÄRKUNG - CORNIERE DE RENFORT DE BORD DE TOIT			4	28x34	2930
GL2	GABLE MOULDING - GIBELLEISTE - PLANCHE DE RIVE			2	18x120	1100
GL3	GABLE MOULDING - GIBELLEISTE PLANCHE DE RIVE			2	18x120	3900
	HAMMER BLOCK - SCHLAGHOLZ - CALLE DE FRAPPE			1		
	LENGTHENING BOLT FOR TREADED ROD - VERLÄNGERUNGSMUTTER FÜR GEWINDESTANGE - MANCHON DE RACCORDEMENT DE TIGE FILETÉE			4		
	SCREW FOR ROOF EDGE REINFORCEMENT - DACHRANDVERSTÄRKUNG VIS DE FIXATION BARRES DE RENFORT A L'EXTREMITE DES VOLIGES SUR PARTIE HAUTE TOITURE			16	4.5x80	
	SCREW FOR GABLE - SCHRAUBEN FÜR GIEBEL - VIS POUR FIXATION DES PIGNONS			21	5x120	
	SCREW FOR ROOF BEAMS - SCHRAUBEN FÜR DACHBALKEN - VIS POUR PANNE DE TOIT			18	5x120	
	SCREW FOR 1. WALL BEAM - SCHRAUBE FÜR 1. BOHLENREIHE - VIS DE FIXATION DES FONDATIONS			8	5x90	
	SET OF DOOR LOCK COVERS - SCHLOSSBLENDEN - SET DE GARNITURES DE SERRURE DE PORTE			1		
	DRIVE NUT TREADED ROD - EINSHLAGMUTTER FÜR GEWINDESTANGE - ÉCROU A FRAPPER POUR TIGE FILITÉE			4		
	SCREW FOR DOORSTEP - SCHRAUBEN FÜR TÜRSWELLE - VIS DE FIXATION DU SEUIL DE PORTE			2	4.5x65	

