

Art. Nr. 2839950

1/6



06.10.2017

Art.Nr. 2839950



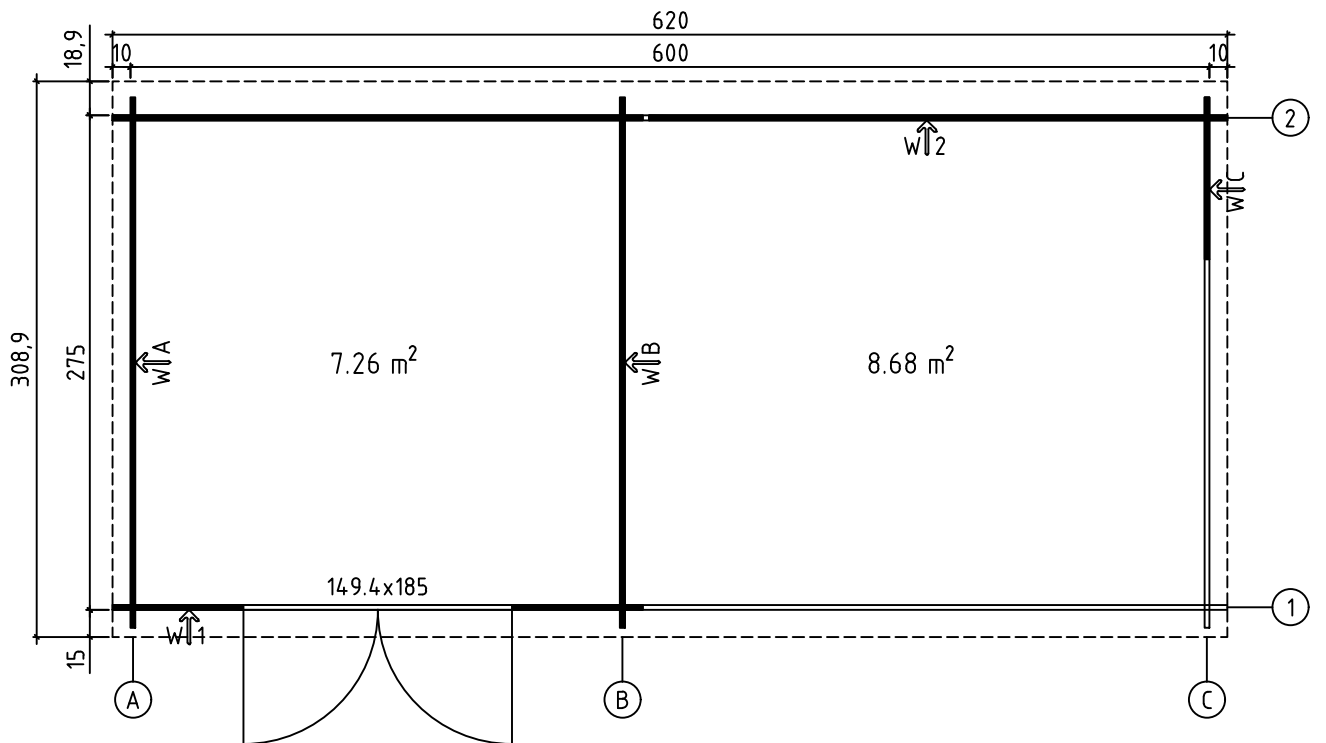

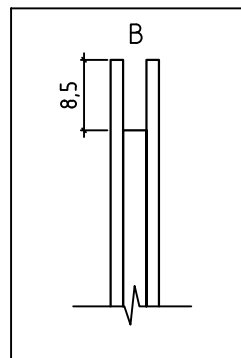
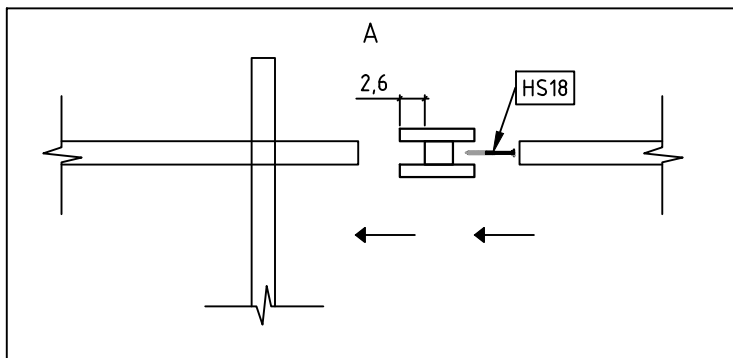
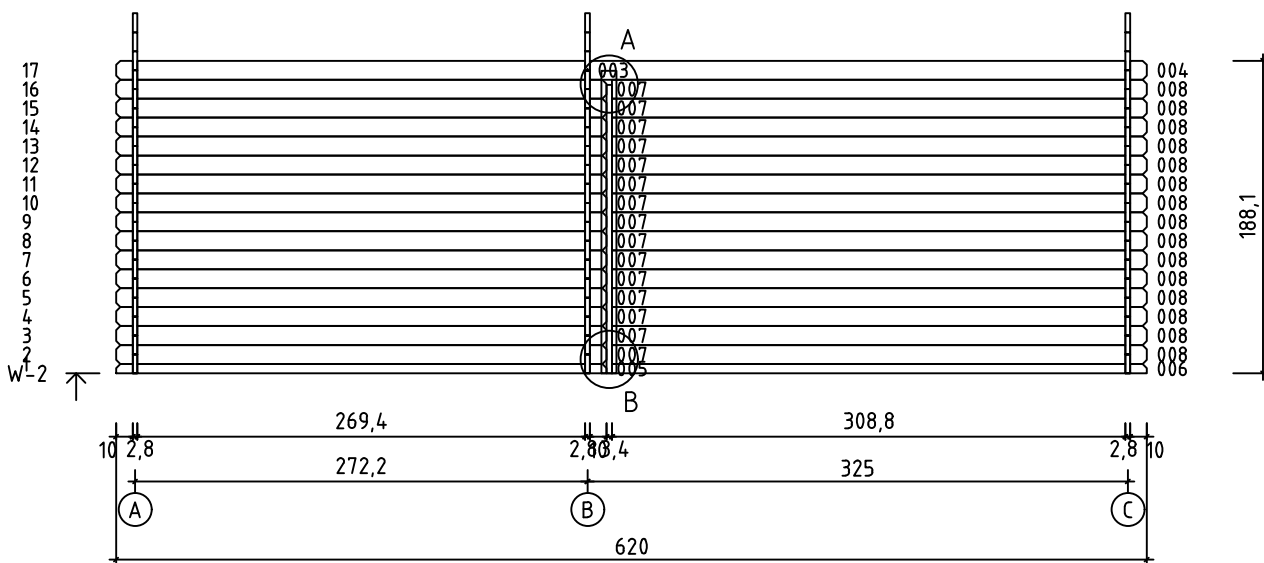
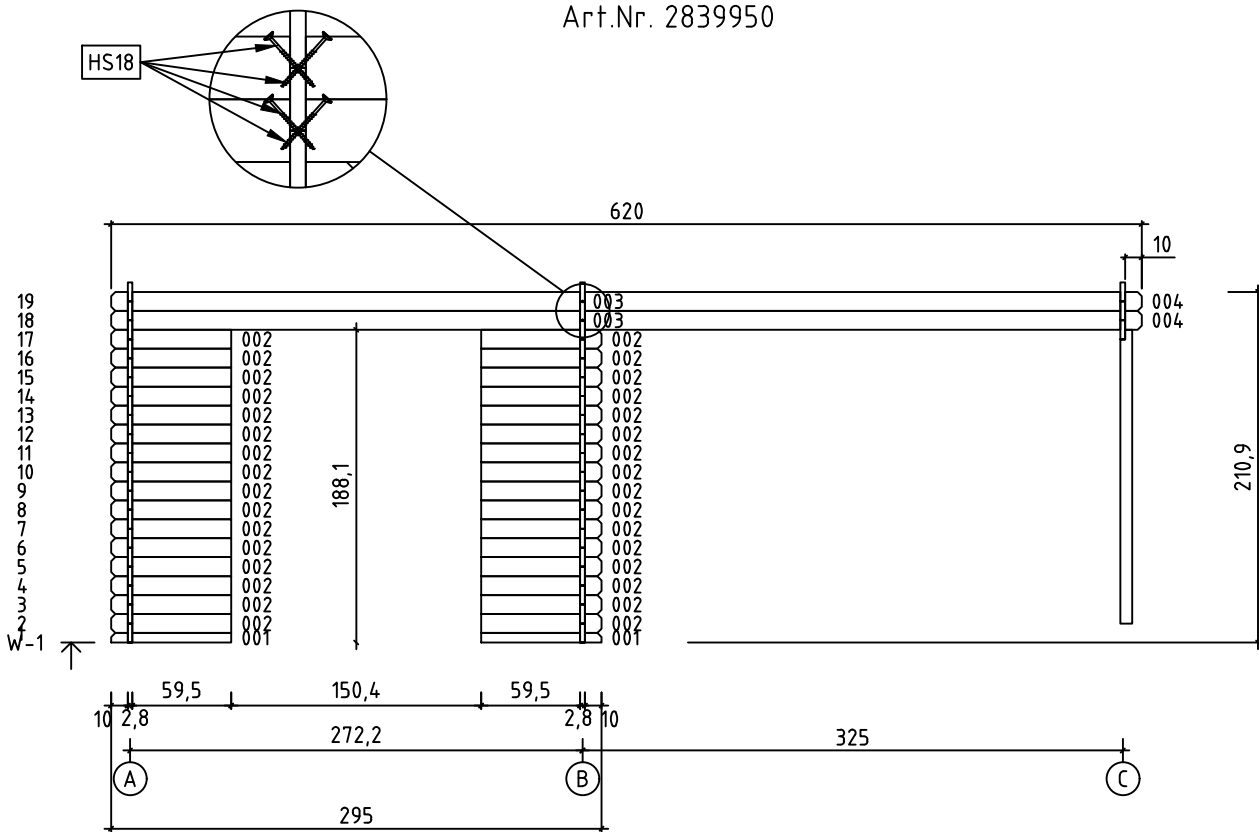

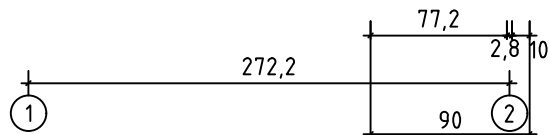
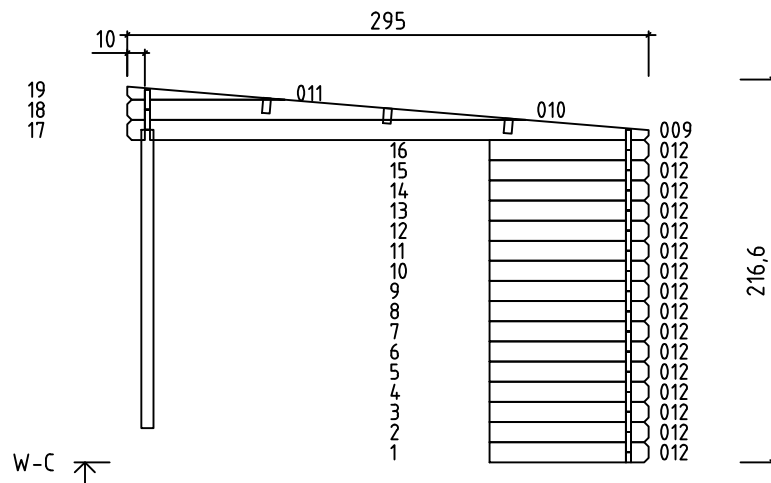
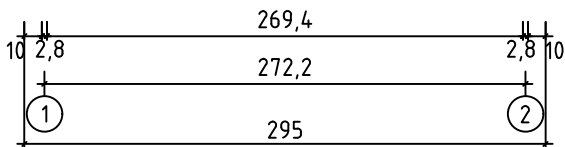
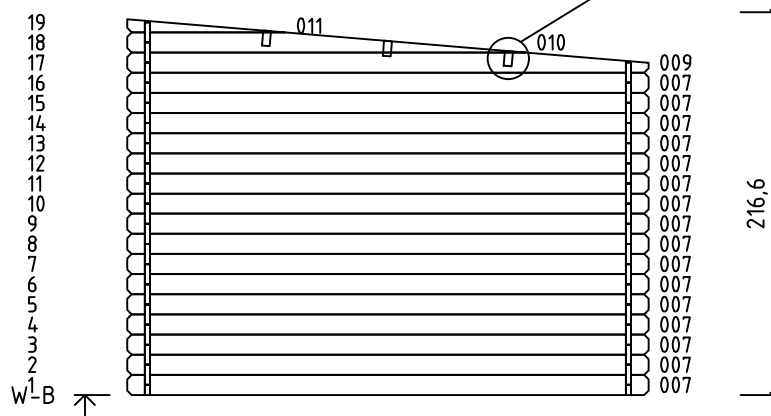
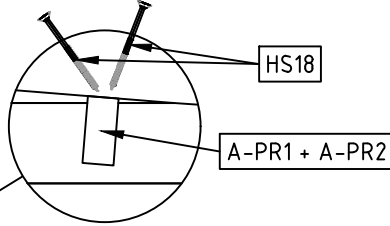
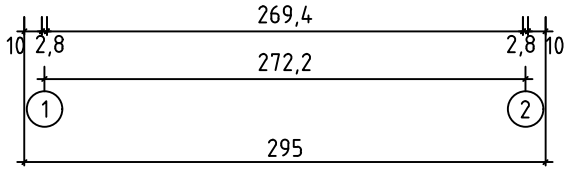
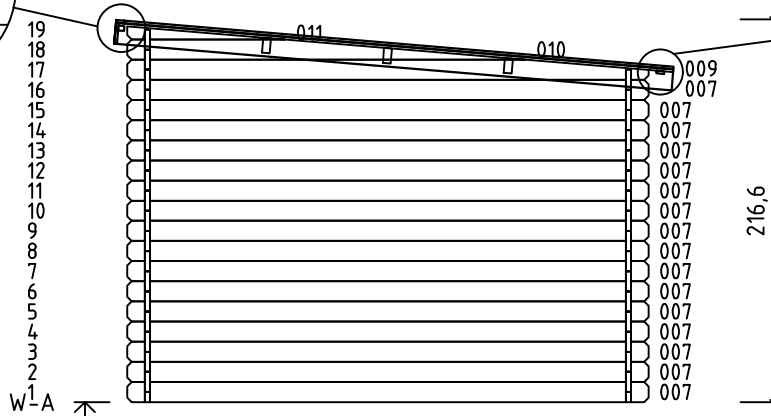
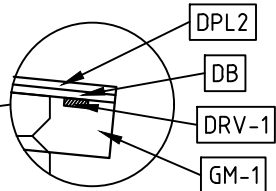
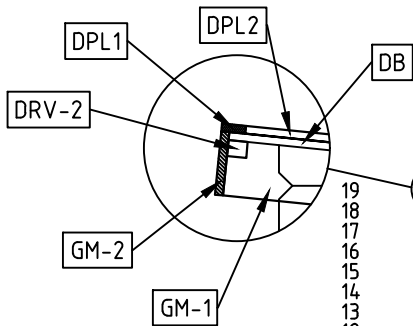

Grundplan - Grundplan - Plan de masse - Planimetria - Plattegrond - Põhiplaan

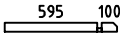
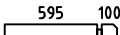
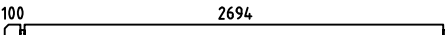
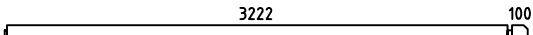
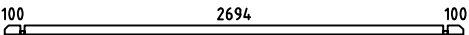
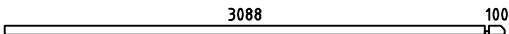
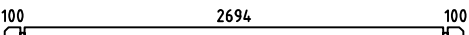
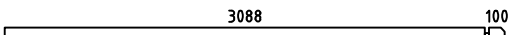
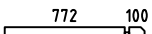
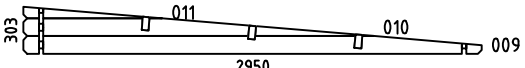
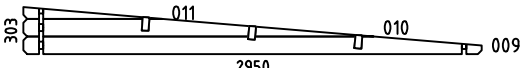
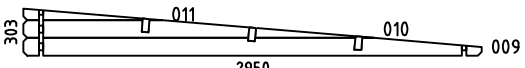
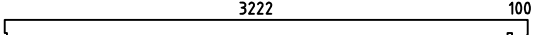
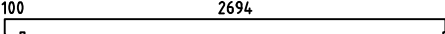
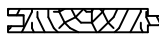



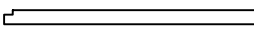



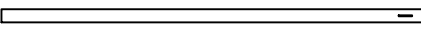

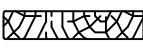
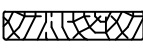













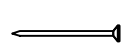
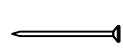

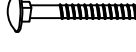

Art.Nr. 2839950

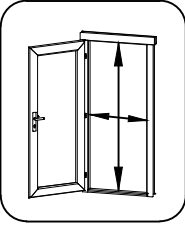
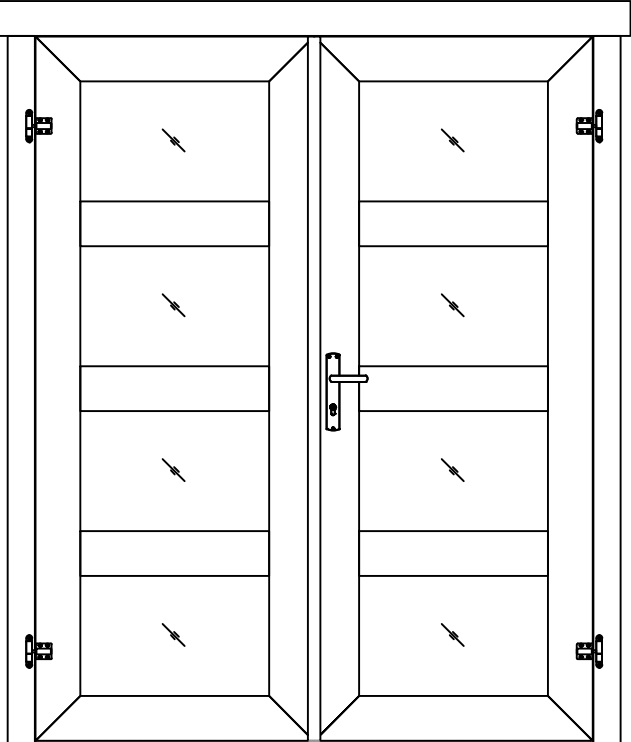

Pos	06.10.2017 Piece list - Stückliste - Liste des pièces - Elementi - Stuklijst - Tükítabel Art.Nr. 2839950	5/6	Q	P (mm)	L (mm)
001			2	28x57	723
002			32	28x114	723
003			3	28x114	2836
004			3	28x114	3364
005			1	28x57	2950
006			1	28x57	3216
007			47	28x114	2950
008			15	28x114	3216
012			16	28x114	900
WA-1			1		
WB-1			1		
WC-1			1		
A-PR2	Roof beam - Dachbalken - Panne de toit - Perlina del tetto - Gordingen / dakbalk - Pärтин 		3	44x140	3364
A-PR1	Roof beam - Dachbalken - Panne de toit - Perlina del tetto - Gordingen / dakbalk - Pärтин 		3	44x140	2836
DB	Roof boards - Dachbretter - Voliges - Perlina per tetto - Dakhout - Katuselaud 		69	90x15	3100
DPL1	Roofing felt fillet - Dachpappenleiste - Baguette de fixation du feutre bitumeux - Asse per fissaggio guaina bituminosa - Afdekljst asfaltpapier - Katusepapiilist 		2	15x45	3115
DPL2	Roofing felt fillet - Dachpappenleiste - Baguette de fixation du feutre bitumeux - Asse per fissaggio guaina bituminosa - Afdekljst asfaltpapier - Katusepapiilist 		2	15x45	3120
DPP-1	Roofing felt (strip) - Dachpappe (bahnen) - Feutre bitumeux (bande) - Cartone catramato - Asfaltpapier (baan) - Katusepapp 		4		6300
	Post - Pfosten - Poteau - Piede registrabile - Stijl - Post 		1	90x90	1730
	H-profile - H-profilis - Profile h - Profilo ad h - H-profiel - H-profiil 		1	90x58	1820
DRV-1	Roof edge reinforcement - Dachrandverstärkung - Corniere de renfort de bord de toit - Rinforzo x tetto - Dakrand versterking - Räästatugevdus 		2	15x45	3100
DRV-2	Roof edge reinforcement - Dachrandverstärkung - Corniere de renfort de bord de toit - Rinforzo x tetto - Dakrand versterking - Räästatugevdus 		2	28x34	3100
KFS-1	Storm protection - Sturmleiste - Latte anti-tempete - Protezione anti vento - Stormverankering / beveiliging - Tormikinnitusliist 		5	22x45	2050

Pos	06.10.2017 Piece list - Stückliste - Liste des pièces - Elementi - Stuklijst - Tükítabel Art.Nr. 2839950 6/6	Q	P (mm)	L (mm)
	U-profile - U-profils - Profile u - Profilo ad u - U-profiel - U-profiil 	1	28x58	1780
	Gable moulding - Giebelleiste - Planche de rive - Finitura per frontale e retro del tetto - Gevellijst - Viilulaud 	2	15x120	3100
	Gable moulding - Giebelleiste - Planche de rive - Finitura per frontale e retro del tetto - Gevellijst - Viilulaud 	2	15x120	3165
HS9	Screw for u-profile - Schraube zur befestigung u-profils - Vis a tete fraisée pour profil u - Vite per profilo ad u - Schroef ter bevestiging u-profiel - Kruvi U-profiilile 	5	3.5x50	
HS9	Screw for gable moulding - Schrauben für giebelleiste - Vis pour fixation planche de rive - Vite per fissare finiture davanti e dietro del tetto - Schroef voor gevellijst - Kruvi viilulauale 	20	3.5x50	
HS4	Screw for roof edge reinforcement - Schrauben für dachrandverstärkung - Vis pour fixation corniere renfort de bord de toit - Viti x rinforzo bordo tetto - Schroef voor dakrand versterking - Kruvi räästatugevdusele 	14	3x30	
HS14	Screw for post - Schrauben für pfosten - Vis de fixation des poteaux - Viti per inviare - Schroef voor stijlen - Kruvi postile 	2	4.5x80	
HS12	Screw for roof edge reinforcement - Schrauben für dachrandverstärkung - Vis pour fixation corniere renfort de bord de toit - Viti x rinforzo bordo tetto - Schroef voor dakrand versterking - Kruvi räästatugevdusele 	14	4x40	
HS12	Screw for gable moulding - Schrauben für giebelleiste - Vis pour fixation planche de rive - Vite per fissare finiture davanti e dietro del tetto - Schroef voor gevellijst - Kruvi viilulauale 	14	4x40	
HS13	Screw for h-profile - Schraube zur befestigung h-profils - Vis a tete fraisée pour profil h - Vite per profilo ad h - Schroef ter bevestiging h-profiel - Kruvi H-profiilile 	1	4x60	
HS18	Screw for roof beams - Schrauben für dachbalken - Vis pour fixation pannes de toit - Viti per perline del tetto - Schroef voor gordingen / dakbalken - Kruvi pärlinitele 	12	5x120	
HS18	Screw for wall details - Schraube für wand details - Vis pour mur details - Viti per elementi della porta - Schroef voor wand details - Kruvi seinadetailidele 	6	5x120	
HS18	Screw for gable - Schrauben für giebel - Vis pour fixation des pignons - Viti per timpano - Schroef voor gevelpunt - Kruvi viilude kinnitamiseks 	12	5x120	
HS20	Screw for post height adjustment - Schrauben für regulierungsschraube für pfosten - Vis de fixation de support réglable de poteau - Viti per fissare ed aggiustare l'altezza del palo verticale - Schroef voor hoogte instelling stijlen - Kruvi vajumispolidile 	8	6x50	
SH28	Hammer block - Schlagholz - Calle de frappe - Blocco di legno da usare come cuscinetto quando si usa il martello - Slagklos - Löögiklots 	1		
SFS	Nut for storm protection - Schraubenmutter für sturmleiste - Erou pour latte anti-tempete - Dado x asta protezione vento - Moer voor stromverankering - Mutter tormikinnitusliistule 	10	D6	
NF4	Zn nail for roof - Zn nägel für dachbretter - Pointe pour fixation voliges de toit - Chiodi x perline tetto - Spijker(nagel) voor dakhout - Nael katuselauale 	362	2x50	
NF5	Zn nail for roofing felt fillet - Zn nägel für dachpappenleiste - Pointe pour baguette de fixation feutre bitumeux - Chiodi x carta bituminosa x tetto - Spijker(nagel) voor asfaltpapier afdekljst - Papiliistunael 	28	2x40	
NF6	Roofing nails for roofing felt - Nägel für dachpappe - Pointe pour fixation feutre bitumeux - Chiodi per cartone catramato - Asfaltnagel - Papinael 	215	2.8x15	
BFS	Bolt for storm protection - Bolzen für sturmleiste - Boulon pour latte anti-tempete - Bullone x asta protezione vento - Bout voor stormankerlat - Puidupolt tormikinnitusliistule 	10	6x60	
DFS	Washer for storm protection - Dichtscheibe für sturmleiste - Rondelle pour latte anti-tempete - Rondella x asta protezione vento - Afdichtring voor storm strip - Seib tormikinnitusliistule 	10	D6	
	Post height adjustment - Regulierungsschraube für pfosten - Support réglable de poteau - Piede registrabile in altezza - Stelschroef voor stijlpost - Vajumispost 	1	D20	
	Door - Tür - Porte - Deur - Uks 1494x1850 TUK.4.020.SVP.MMX28 SGA+28	1		

Pos	18.12.2017	Piece list - Stückliste - Liste des pièces - Elementi - Stuklijst - Tükítabel 1494x1850 TUK.4.020.SVP.MMX28 SGA+28	1/2	Q	P (mm)	L (mm)	
Glass size - Glasgröße - Taille de la vitre - Misura del vetro - Glas afmeting - Klaasi mõõt: 502x325 mm					 1418x1792 mm		
							
1	Upper door jamb - Türrahmen oben - Cadre de porte supérieur - Telaio superiore della porta - Bovendorpel - Ukse ülemine leng				1	66x100	1438
2	Left door jamb - Türrahmen links - Cadre de porte gauche - Telaio montante sinistro della porta - Linkerstijl deurframe - Ukse vasak leng				1	66x80	1850
3	Right door jamb - Türrahmen rechts - Cadre de porte droit - Telaio montante destro della porta - Rechterstijl deurframe - Ukse parem leng				1	66x80	1850
4	Doorstep - Swelle - Barre de seuil - Soglia della porta - Deurdorpel - Lävepakk				1	20x21	1418
5	Connection strip - Deckleiste - Baguette de battement - Profilo verticale della porta - Stulplijst - kokkuvaltsiliist				1	13x32	1812

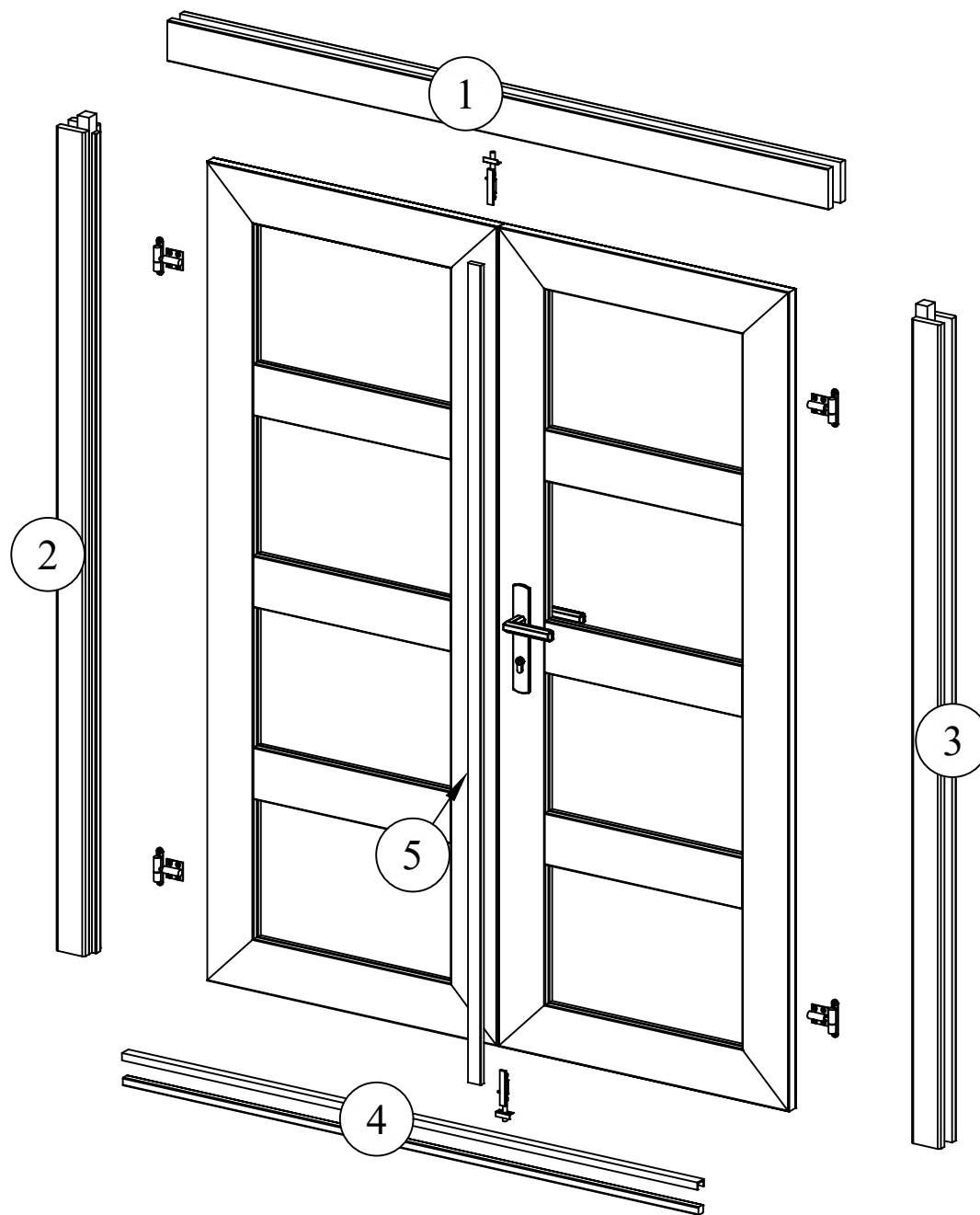

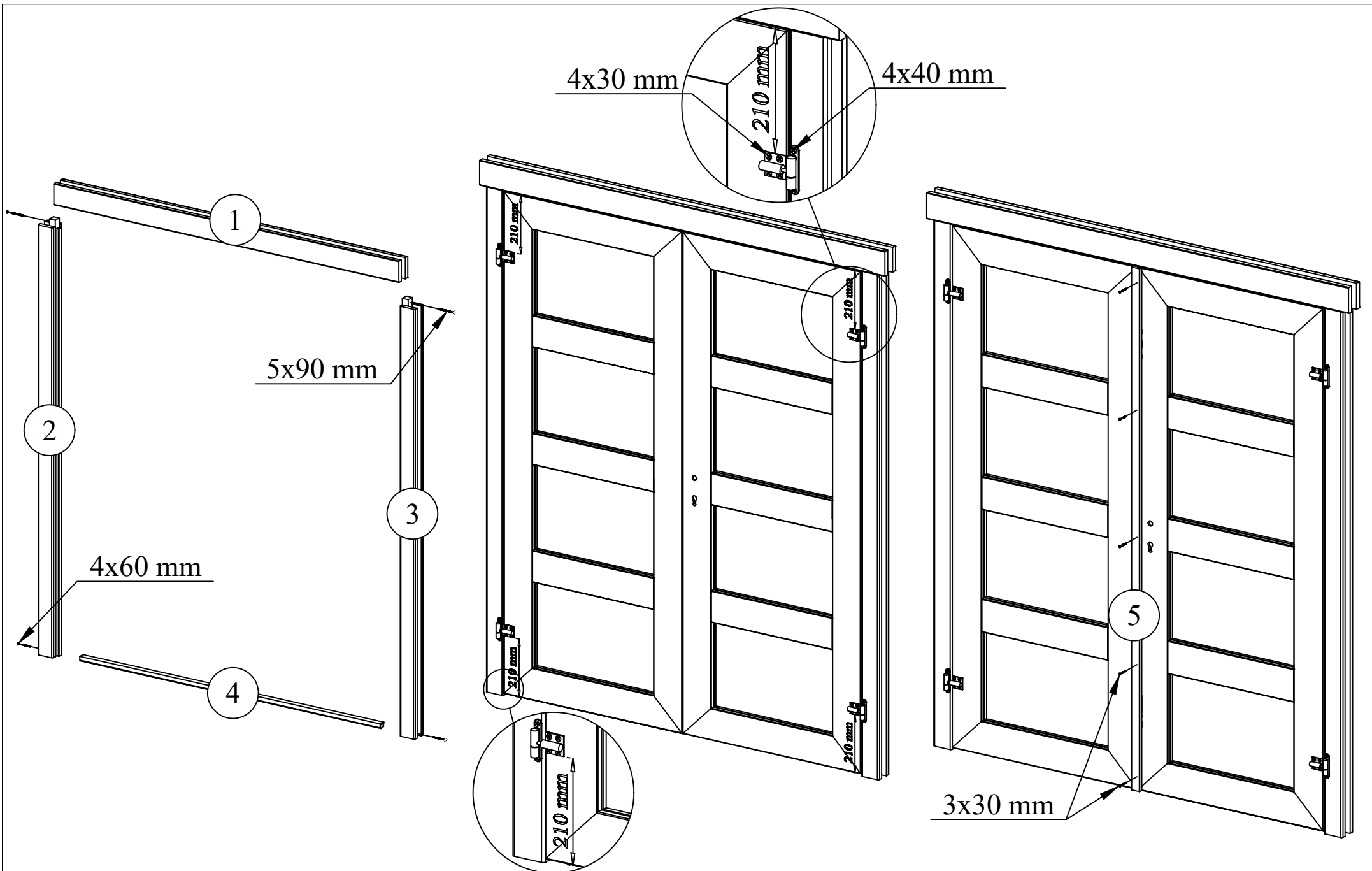

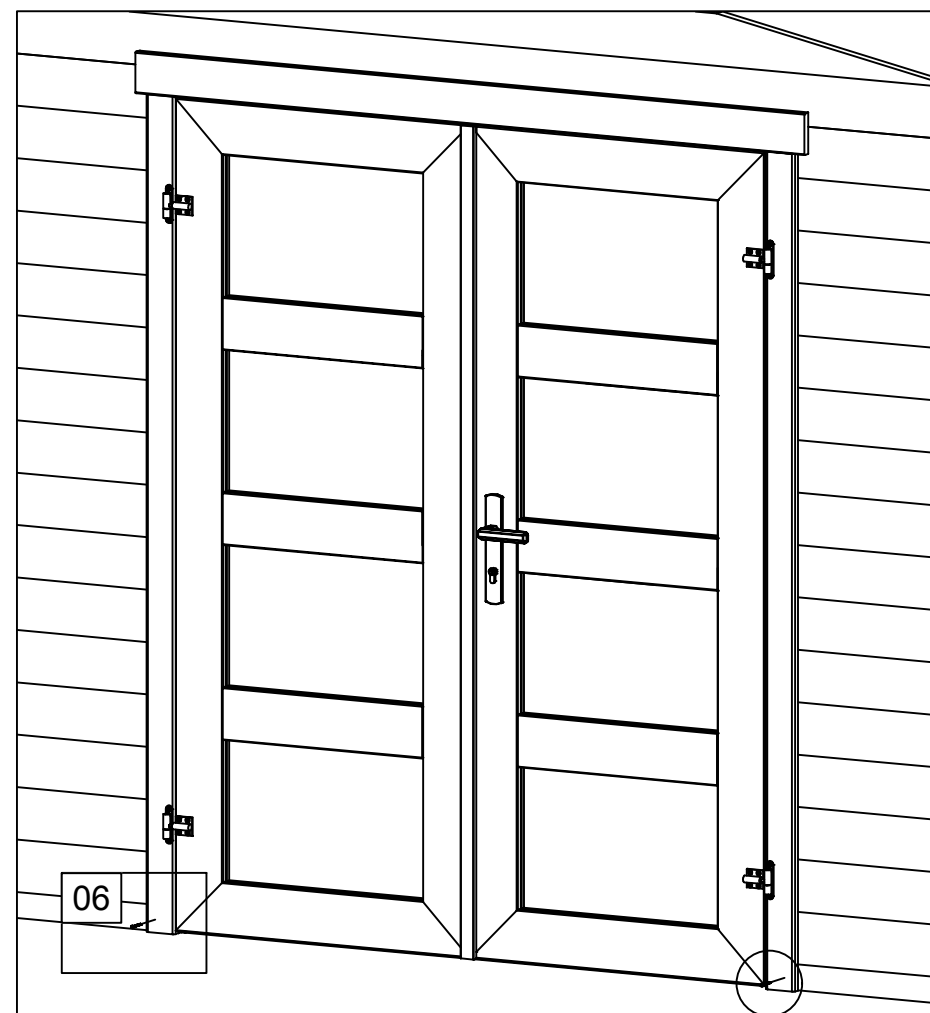
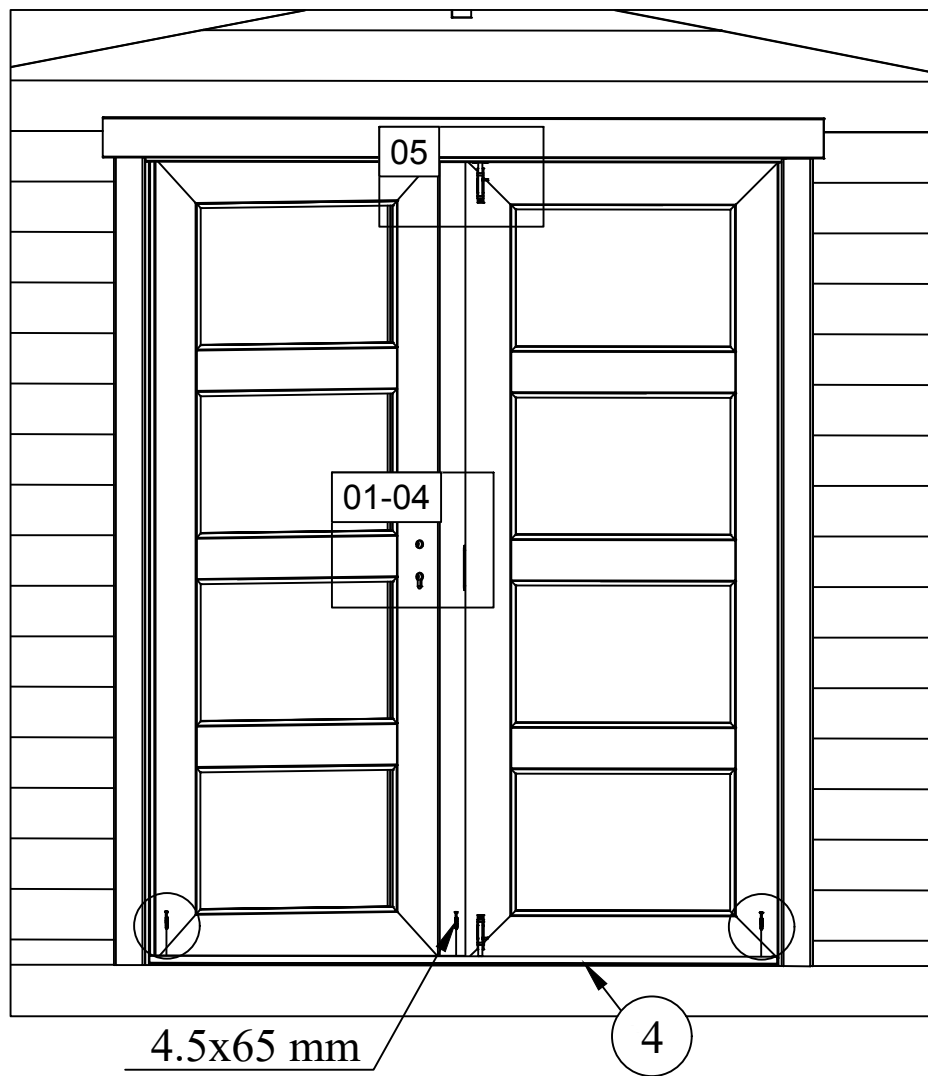

01

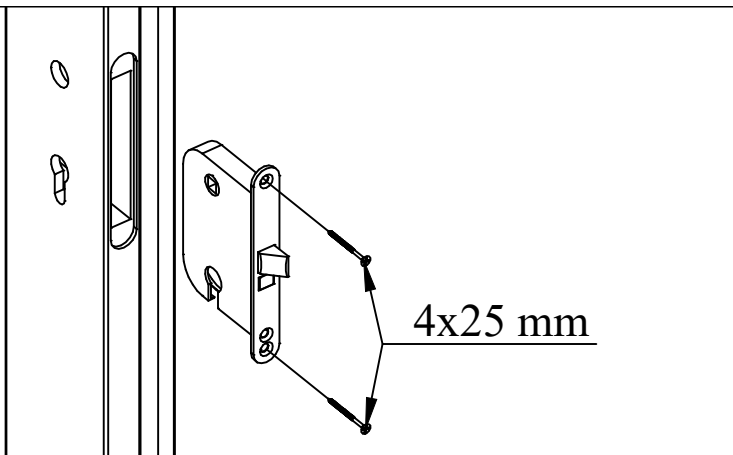

04

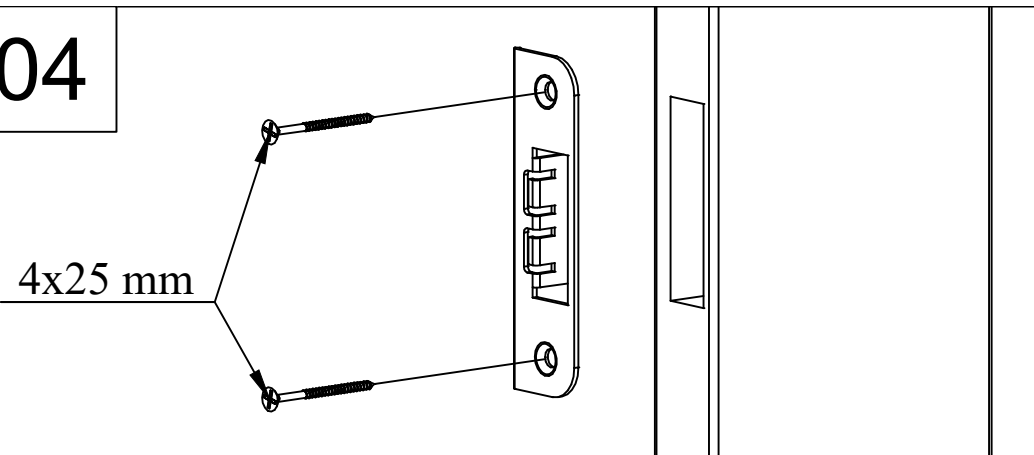

02



05

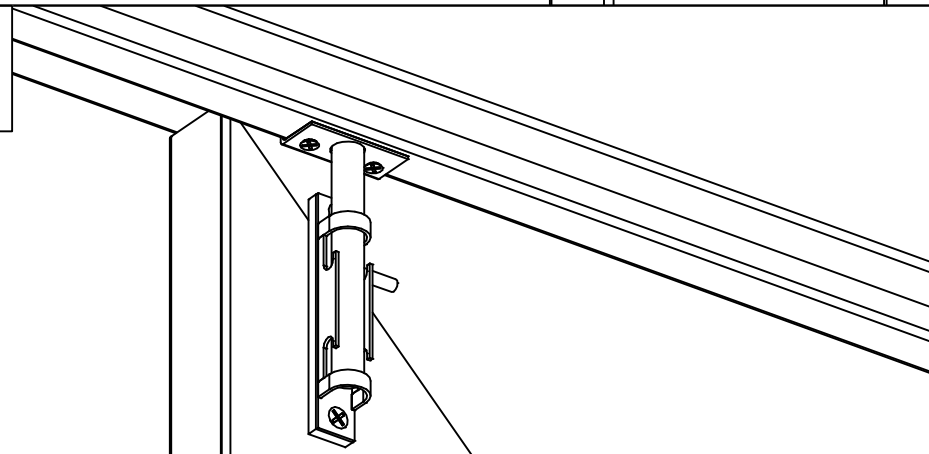

03

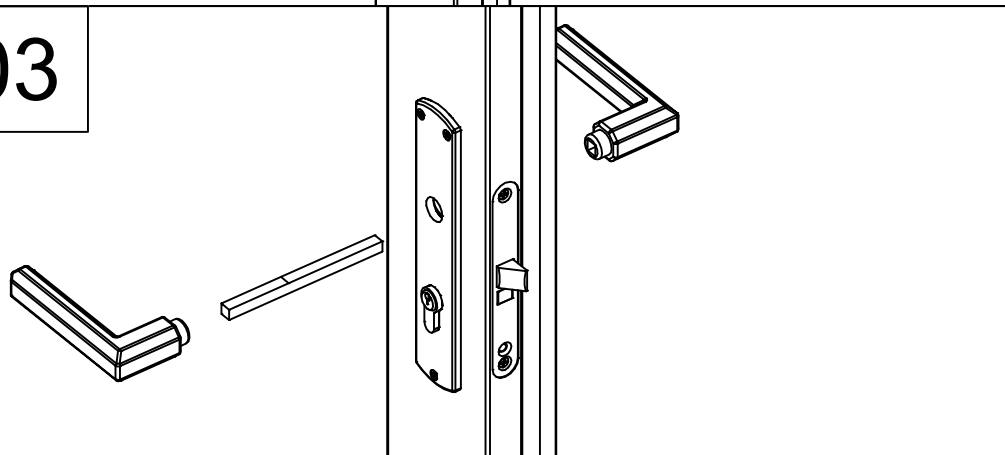

06

